



Sürtünme Plakası / Sliding Pad

Not / Note

Tüm köşelere paid kesilmezler
Break all sharp edges
Toleranslar tüm ölçüler
EN 22768-1 standardlarında
All dimensions without tolerance
as per EN 22768-1

Sipariş Kodu / Order Code
SPB08 - W - L

Malzeme / Material

SAE430B + Graphite

Referans Kod / Reference Code

VDI 3357
VW / AUDI
BMW
FORD WDX

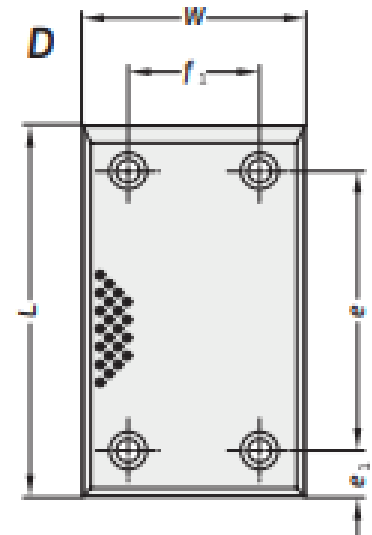
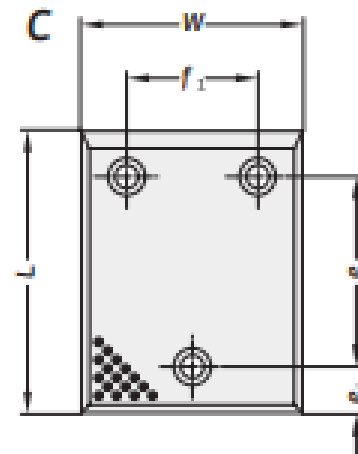
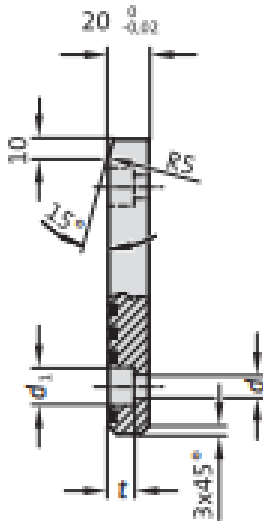
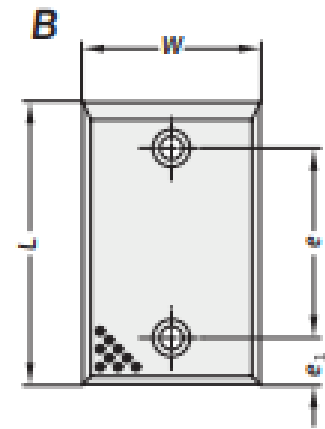
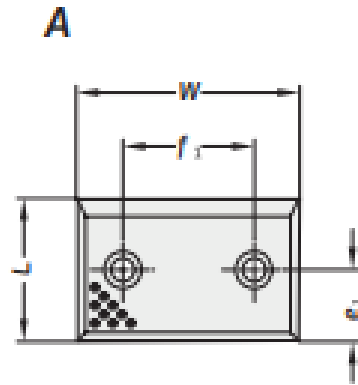
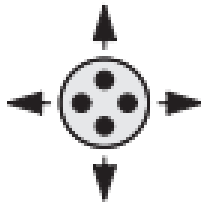
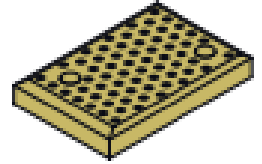

Sipariş Kodu / Order Code	Form	W	L	e ₁	e	f ₁	d	d ₁	t	Civata/ Screws
SPB08-50-80	B	50	80	25	30	-	9	15	9	2
SPB08-50-100	B	50	100	25	50	-	13,5	20	13	2
SPB08-50-125	B	50	125	25	75	-	13,5	20	13	2
SPB08-50-160	B	50	160	25	110	-	13,5	20	13	2
SPB08-50-200	B	50	200	25	150	-	13,5	20	13	2
SPB08-80-50	A	80	50	25	-	30	9	15	9	2
SPB08-80-80	B	80	80	25	30	-	13,5	20	13	2
SPB08-80-100	B	80	100	25	50	-	13,5	20	13	2
SPB08-80-125	B	80	125	25	75	-	13,5	20	13	2
SPB08-80-160	B	80	160	25	110	-	13,5	20	13	2
SPB08-80-200	B	80	200	25	150	-	13,5	20	13	2
SPB08-80-250	B	80	250	40	170	-	13,5	20	13	2
SPB08-80-315	B	80	315	40	235	-	13,5	20	13	2
SPB08-100-50	A	100	50	25	-	50	13,5	20	13	2
SPB08-100-80	A	100	80	40	-	50	13,5	20	13	2
SPB08-100-100	B	100	100	25	50	-	13,5	20	13	2
SPB08-100-125	B	100	125	25	75	-	13,5	20	13	2
SPB08-100-160	B	100	160	25	110	-	13,5	20	13	2
SPB08-100-200	B	100	200	25	150	-	13,5	20	13	2
SPB08-100-250	B	100	250	40	170	-	13,5	20	13	2
SPB08-100-315	B	100	315	40	235	-	13,5	20	13	2
SPB08-125-50	A	125	50	25	-	75	13,5	20	13	2
SPB08-125-80	A	125	80	40	-	75	13,5	20	13	2
SPB08-125-100	C	125	100	25	50	75	13,5	20	13	3
SPB08-125-125	C	125	125	25	75	75	13,5	20	13	3
SPB08-125-160	C	125	160	25	110	75	13,5	20	13	3
SPB08-125-200	C	125	200	25	150	75	13,5	20	13	3
SPB08-125-250	C	125	250	40	170	75	13,5	20	13	3
SPB08-125-315	C	125	315	40	235	75	13,5	20	13	3
SPB08-160-50	A	160	50	25	-	110	13,5	20	13	2
SPB08-160-80	A	160	80	40	-	110	13,5	20	13	2
SPB08-160-100	C	160	100	25	50	110	13,5	20	13	3
SPB08-160-125	C	160	125	25	75	110	13,5	20	13	3
SPB08-160-160	C	160	160	25	110	110	13,5	20	13	3
SPB08-160-200	C	160	200	25	150	110	13,5	20	13	3
SPB08-160-250	D	160	250	40	170	110	13,5	20	13	4
SPB08-160-315	D	160	315	40	235	110	13,5	20	13	4