

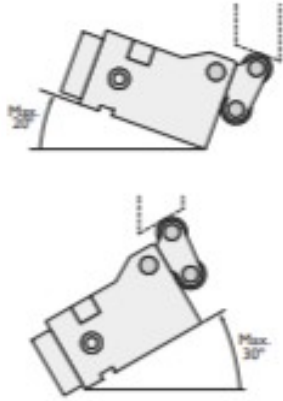

Çalışma Açısı / Work Angle

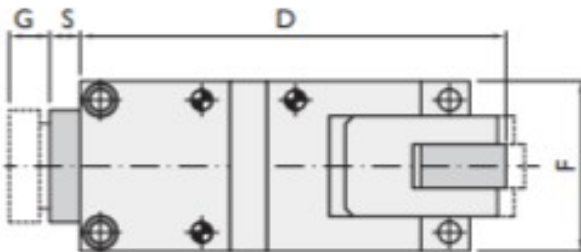

Kam Diyagramı / Cam Diagram

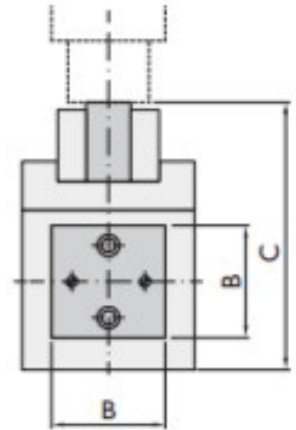
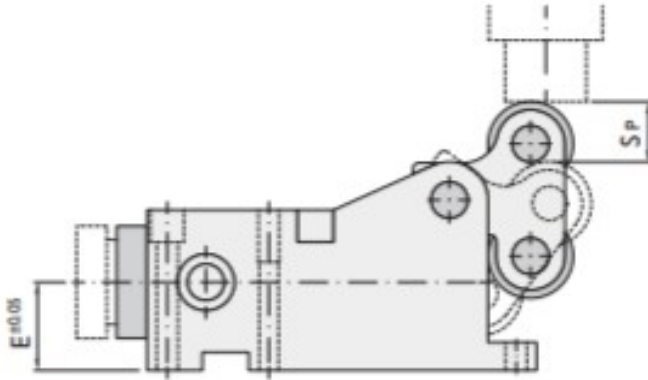
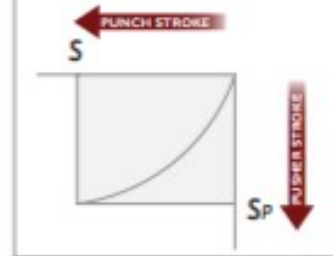

Kam Kodu Cam Kode	Kuvvet Force (daN)	Kurs Travel (S)	Ölçüler / Dimensions (mm)							
			B	C	D	E	F	G	Sp	kg
MK01	750	10	44,5	50	80	18	44,5	20	7,5	0,9
MK01	1500	12	45	76	104	28	65	15	11,5	2,6
MK01	3500	20	45	84	152	28	75	15	24,5	4,1
MK01	5000	25	45	116	163,5	37	80	15	25	6,1
MK01	7000	38	56	134	210	44	85	15	42,5	9,2
MK01	10000	50	63	149,5	240,5	50	96	15	52,7	13,8

 ORDER	Kod / Code	Kuvvet / Force daN	Kurs / Travel (S)
	MK01	10000	50



Çalışma Açısı / Work Angle

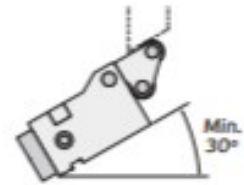

Min.  
30°

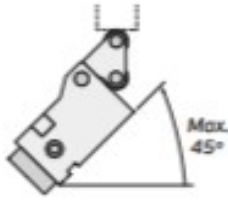

Max.  
45°

■ Kam Diyogram / Cam Diagram

PUNCH STROKE

S



Sp

PUNCH STROKE

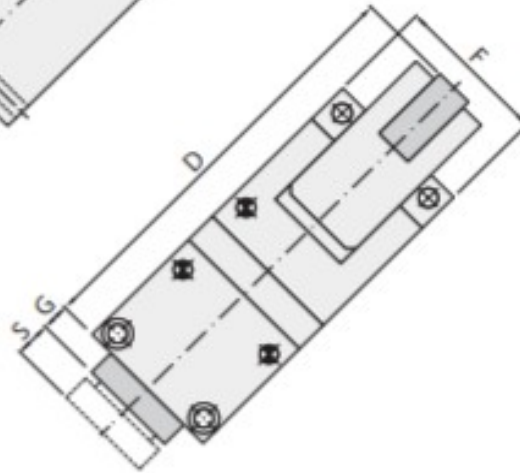
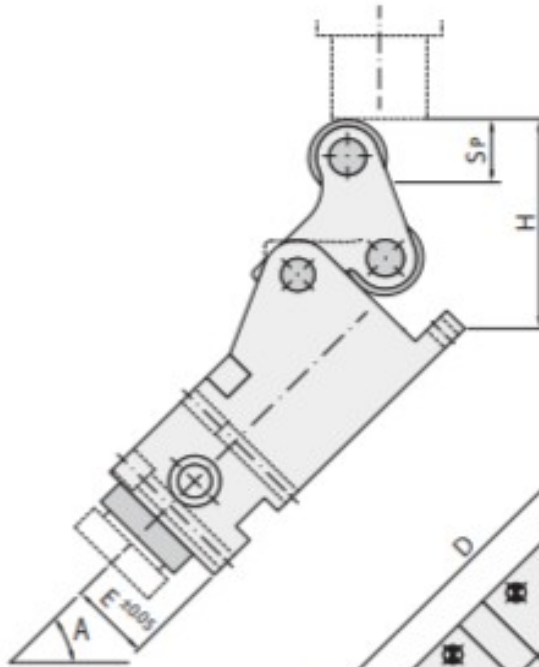

Kam Kodu Cam Kode	Kuvvet Force (daN)	Kurs Travel (S)	Açı Angle (A°)	Ölçüler / Dimensions (mm)								
				B	C	D	E	F	G	H	Sp	kg
MK01	5000	25	45	45	98	198,5	37	80	15	97	37,5	6,5
MK01	7000	38	45	56	122	255,5	44	85	15	122,6	58,5	9,5
MK01	10000	50	45	63	131	283,5	50	96	15	125,7	64,5	14

 ORDER	Kod / Code	Kuvvet / Force daN	Kurs / Travel (S)	Açı / Angle (45°)
	MK01	7000	50	45