

DKH-250 Bilgilendirme / Information

- Çalışma Kuvveti / Working Force : (300.000 Baskı/Stroke)235,2 kN(24,0tonf)
- Sürücü Geniřliđi / Slider Width : 250 mm
- Çalışma Açısı / Work Angle : 0°
- Sipariş Örneđi / Order Example : DKH-250-00-40

Kam Diyagramı / Cam Diagram

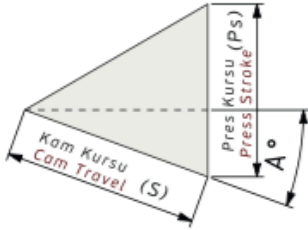

Sipariş Örneđi / Order Example

Kam Kodu Cam Code	Sürücü Geniřliđi Slider Width (mm)	Çalışma Açısı Work Angle (°)	Kurs Travel (mm)	Opsiyon Kodu / Option Code		
				---	---	---
DKH -	250	- 00	- 40			
DKH -	250	- 00	- 60			

DKH-250 Teknik Bilgiler / Technical Informations

Çalışma Yüzeyi/Mounting Surface		Çalışma Açısı Work Angle (°)	Kam Kuru/Cam Travel Stroke (mm)	Çalışma Kuvveti Working Force	Yay Kuvveti Spring Force	Gazlı Yay Kuvveti Gas Spring Force
(G)	(Gh)					
250	130	00	40	300.000 Baskı/Stroke		7940 N (810 kgf)
250	130	00	60	235,2 kN (24,0 tonf)		7940 N (810 kgf)

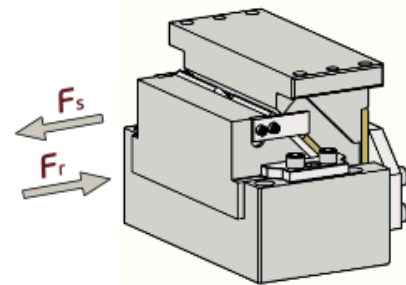
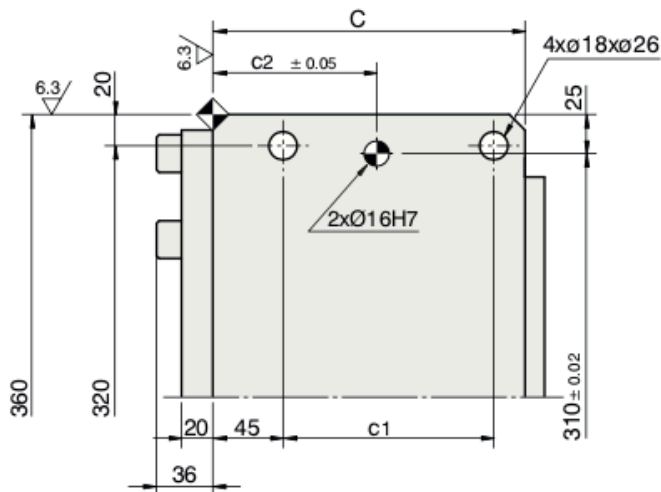
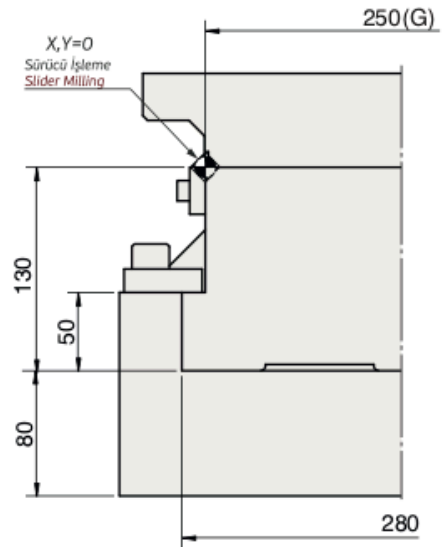
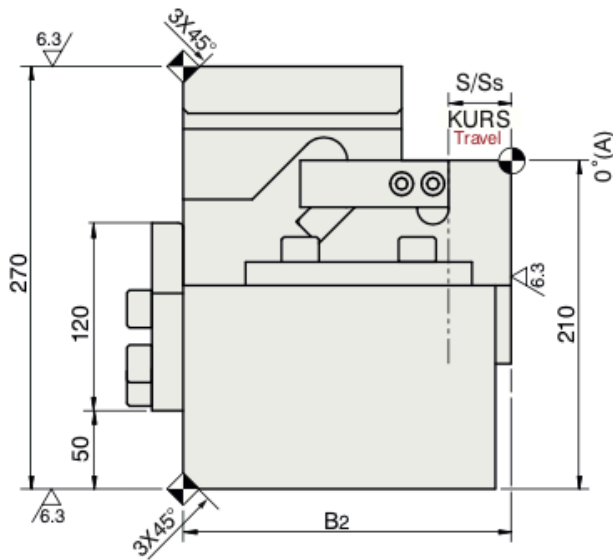
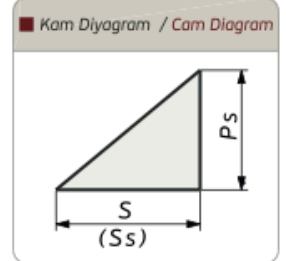
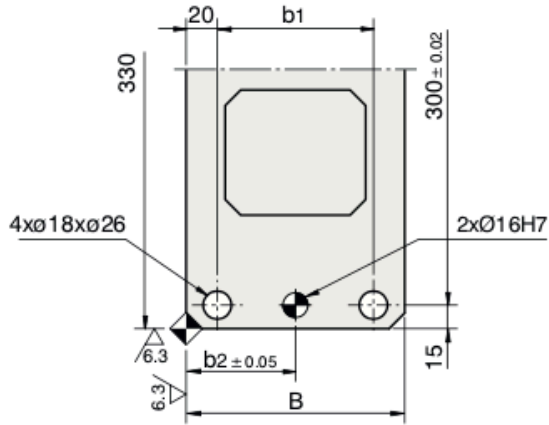

Sipariş Kodu Order Kode	Açı Angle (A)	Ölçüler / Dimensions (mm)									
		S	P _s	S _s	B	B ₂	b ₁	b ₂	C	c ₁	c ₂
DKH-250-00-40	00	40	40	40	140	210	100	70	200	135	105
DKH-250-00-60	00	60	60	60	160	230	120	80	220	155	125

 Kod / Code	(G)	(A)	(S)
DKH	250	00	60