

DKH-100 Bilgilendirme / Information

- Çalışma Kuvveti / Working Force : (300.000 Baskı/Stroke) 78,4 kN (8,0 tonf)
- Sürücü Geniřliđi / Slider Width : 100 mm
- Çalışma Açısı / Work Angle : 0°-20°
- Sipariř Örneđi / Order Example : DKH-100-20-45

Kam Diyagram / Cam Diagram

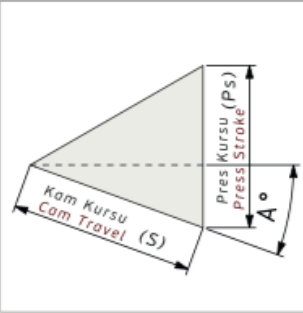

Sipariř Örneđi / Order Example

Kam Kodu Cam Code	Sürücü Geniřliđi Slider Width (mm)	Çalışma Açısı Work Angle (°)	Kurs Travel (mm)	Opsiyon Kodu / Option Code		
				(G)	(A)	(S)
DKH - 100 - 00 - 80				---	---	---
DKH - 100 - 05 - 70						
DKH - 100 - 20 - 45						

DKH-100 Teknik Bilgiler / Technical Informations

Çalışma Yüzeyi/Mounting Surface		Çalışma Açısı Work Angle (°)	Kam Kursu/Cam Travel Stroke (mm)	Çalışma Kuvveti Working Force	Yay Kuvveti Spring Force	Gazlı Yay Kuvveti Gas Spring Force
(G)	(Gh)					
100	100	00	40	300.000 Baskı/Stroke 78,4 kN (8,0 tonf)		5190 N (530 kgf)
100	100	00	60			5190 N (530 kgf)
100	100	00	80			5190 N (530 kgf)
100	90	05	45			5190 N (530 kgf)
100	90	05	70			5190 N (530 kgf)
100	90	10	45			5190 N (530 kgf)
100	90	10	70			5190 N (530 kgf)
100	90	15	45			5190 N (530 kgf)
100	90	15	70			5190 N (530 kgf)
100	90	20	45			5190 N (530 kgf)
100	90	20	70			5190 N (530 kgf)

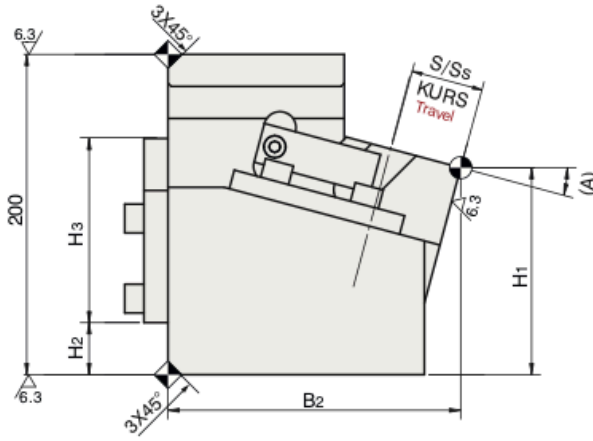
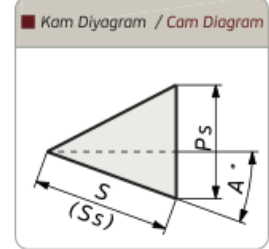
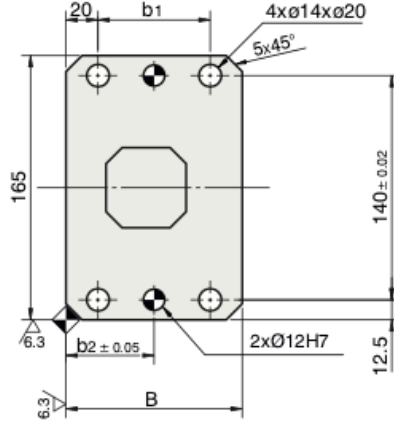

X,Y=0
Sürücü İşleme
Slider Milling

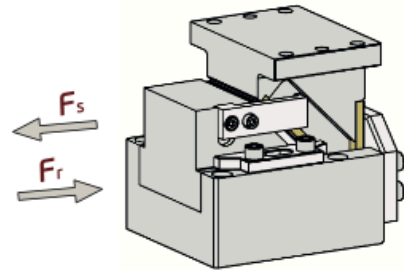
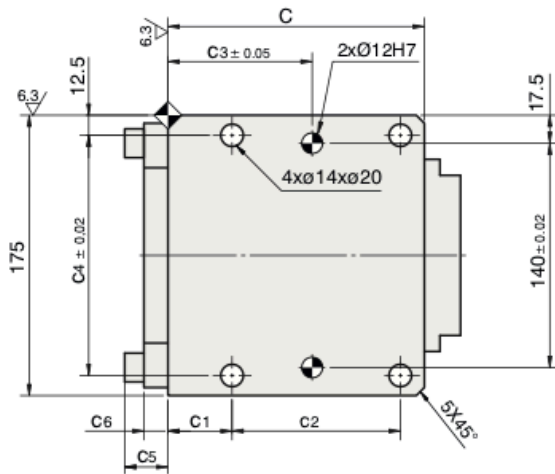
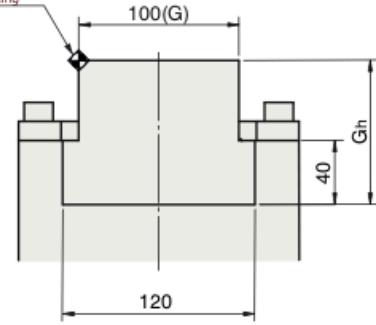

Sipariş Kodu Order Kode	Açı Angle (A)	Ölçüler / Dimensions (mm)								
		S	Ps	Ss	H1	H2	H3	B	B2	Gh
DKH-100-00-40	00	40	40,0	40	150,0	30	60	120	190,0	100
DKH-100-00-60	00	60	60,0	60	150,0	30	60	140	210,0	100
DKH-100-00-80	00	80	80,0	80	150,0	10	115	150	250,0	100
DKH-100-05-45	05	45	67,9	45	145,3	27,5	115	100	172,3	90
DKH-100-05-70	05	70	105,7	70	147,2	30	115	120	207,1	90
DKH-100-10-45	10	45	60,6	45	135,0	30	115	100	178,2	90
DKH-100-10-70	10	70	94,3	70	133,9	30	115	120	212,6	90
DKH-100-15-45	15	45	55,1	45	129,2	32,5	115	110	182,7	90
DKH-100-15-70	15	70	85,7	70	130,2	35	115	130	216,5	90
DKH-100-20-45	20	45	50,9	45	118,1	35	115	110	185,9	90
DKH-100-20-70	20	70	79,1	70	121,2	45	115	130	218,8	90

Sipariş Kodu Order Kode	Açı Angle (A)	Ölçüler / Dimensions (mm)								
		b1	b2	C	c1	c2	c3	c4	c5	c6
DKH-100-00-40	00	80	60	190	45	130	105	140	28	16
DKH-100-00-60	00	100	70	190	45	130	105	140	28	16
DKH-100-00-80	00	110	75	220	45	160	135	140	27	15
DKH-100-05-45	05	60	50	160	40	105	90	140	27	15
DKH-100-05-70	05	80	60	190	45	130	70	150	27	15
DKH-100-10-45	10	60	50	160	40	105	90	140	27	15
DKH-100-10-70	10	80	60	190	45	130	70	150	27	15
DKH-100-15-45	15	70	55	160	40	105	90	140	27	15
DKH-100-15-70	15	90	65	190	45	130	70	150	27	15
DKH-100-20-45	20	70	55	160	40	105	90	140	27	15
DKH-100-20-70	20	90	65	190	45	130	70	150	27	15

	Kod / Code	(G)	(A)	(S)
	DKH	100	05	70