

**DAK-65 Bilgilendirme / Information**

- Çalışma Kuvveti / Working Force : (300.000 Baskı/Stroke) 39,2 kN (4,0tonf)
- Sürücü Genişliği / Slider Width : 65 mm
- Çalışma Açısı / Work Angle : 0° ~ 20°
- 02 : CK45, 01 : GGG60 (Opsiyon) / 02 : CK45, 01 : GGG60 (Option)
- Sürtünme Plakası Opsiyonu / Wear Plate Option : P
- Gazlı Yay Opsiyonu / Gas Spring Option : GY
- Pim Deliği Ø10H7 (Opsiyon) / Dowel Pin Ø10H7 (Option)
- Isıl İşlem Opsiyonu / Induction Option : I

**Kam Diyagramı / Cam Diagram**

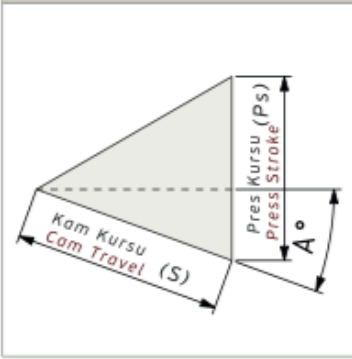

**Sipariş Örneği / Order Example**

Kam Kodu Cam Code	Sürücü Genişliği Slider Width (mm)	Çalışma Açısı Work Angle (°)	Kurs Travel (mm)	Malzeme Material	Opsiyon Kodu / Option Code
	<b>(G)</b>	<b>(A)</b>	<b>(S)</b>	<b>01 / 02</b>	<b>P-GY-F10-I Opsiyonları</b> <b>P-GY-F10-I Option</b>
DAK -	65	- 05	- 45	- 02	
DAK -	65	- 20	- 70	- 01	- P - GY
DAK -	65	- 15	- 45	- 01	- P - GY - F10 - I

**DAK-65 Teknik Bilgiler / Technical Informations**

Çalışma Yüzeyi/Mounting Surface		Çalışma Açısı Work Angle (°)	Kam Kursu/Cam Travel Stroke (mm)	Çalışma Kuvveti Working Force	Yay Kuvveti Spring Force	Gazlı Yay Kuvveti Gas Spring Force (Opsiyon/Option)
(G)	(Gh)	(A)	(S)			
65	70	05	45		745 N (76 kgf)	2646 N (270 kgf)
65	70	05	70		970 N (99 kgf)	2646 N (270 kgf)
65	70	10	45	300.000 Baskı/Stroke	745 N (76 kgf)	2646 N (270 kgf)
65	70	10	70	39,2 kN (4,0 tonf)	970 N (99 kgf)	2646 N (270 kgf)
65	70	15	45	1.000.000 Baskı/Stroke	745 N (76 kgf)	2646 N (270 kgf)
65	70	15	70	19,6 kN (2,0tonf)	970 N (99 kgf)	2646 N (270 kgf)
65	70	20	45		745 N (76 kgf)	2646 N (270 kgf)
65	70	20	70		970 N (99 kgf)	2646 N (270 kgf)

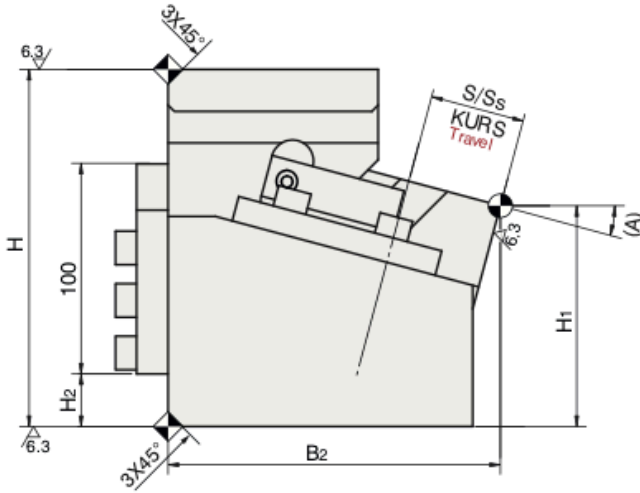
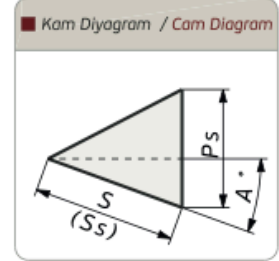
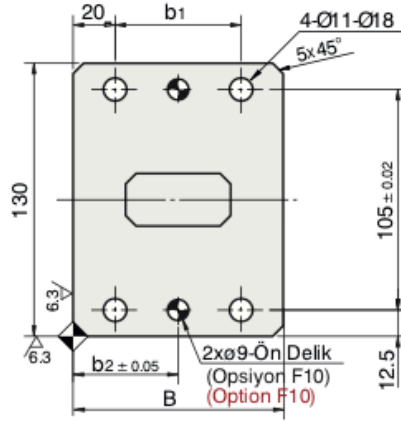

X,Y=0  
Sürücü İşleme  
Slider Milling

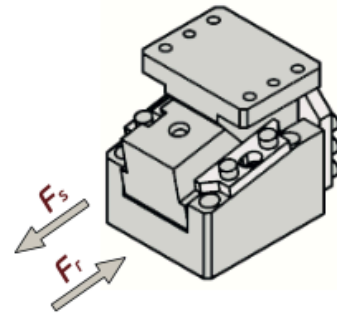
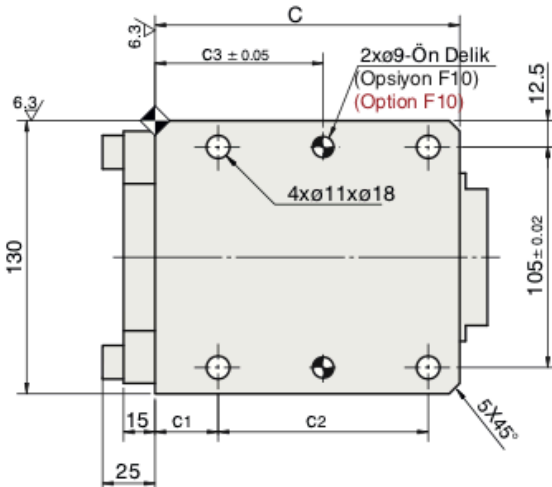
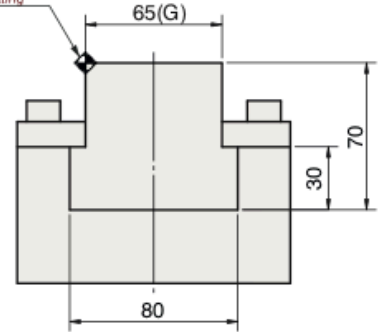

Kam Kodu Cam Kode	Açı Angle (A)	Ölçüler / Dimensions (mm)													
		S	Ps	Ss	H	H1	H2	B	B2	b1	b2	C	c1	c2	c3
DAK-65	05	45	67,9	45	160	112,1	12,5	100	150,6	60	50	145	30	100	80
DAK-65	05	70	105,7	70	170	123,2	25,0	100	195,4	60	50	180	40	125	65
DAK-65	10	45	60,6	45	160	108,8	20,0	100	155,0	60	50	145	30	100	79
DAK-65	10	70	94,3	70	170	110,9	25,0	100	199,3	60	50	180	40	125	65
DAK-65	15	45	55,1	45	170	105,1	25,0	100	158,2	60	50	145	30	100	80
DAK-65	15	70	85,7	70	170	103,5	25,0	110	201,7	70	55	180	40	125	65
DAK-65	20	45	50,8	45	170	101,2	30,0	100	160,3	60	50	145	30	100	80
DAK-65	20	70	79,1	70	170	95,8	40,0	110	202,5	70	55	180	40	125	65

 <b>ORDER</b>	Kod / Code	(G)	(A)	(S)	Opsiyon / Option
	DAK	65	10	70	02/01 - P - F10 - GY - I