

AKVS-85 Bilgilendirme / Information

- Çalışma Kuvveti / Working Force : (1.000.000 Baskı/Stroke)58,8 kN(6,0tonf)
- Sürücü Genişliği / Slider Width : 85 mm
- Çalışma Açısı / Work Angle : 0°~20°
- SU Opsiyonu / SU Option : 1~40 mm
- Sipariş Örneği / Order Example : AKVS-85-05

Kam Diyagramı / Cam Diagram

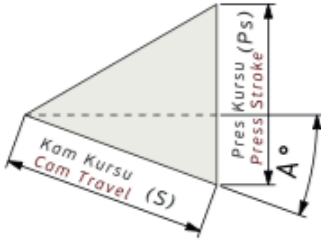

Sipariş Örneği / Order Example



Kam Kodu Cam Code	Sürücü Genişliği Slider Width (mm)	Çalışma Açısı Work Angle (°)	Opsiyon Kodu / Option Code		
	(G)	(A)	Sürücü Uzunluğu Slider Length	---	---
AKVS - 85 - 00	85	00			
AKVS - 85 - 20 - SU35	85	20	SU35		

AKVS-85 Teknik Bilgiler / Technical Informations

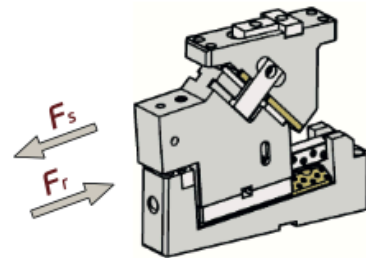
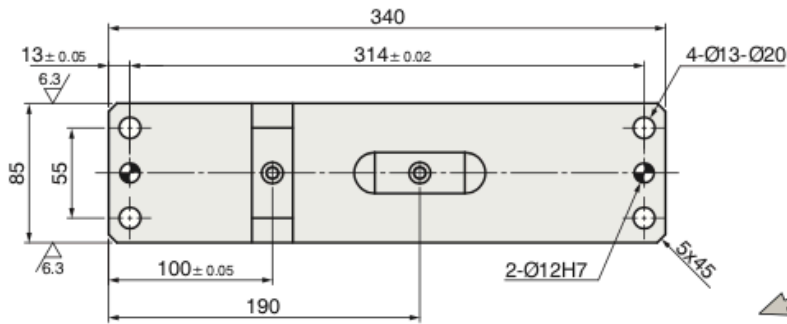
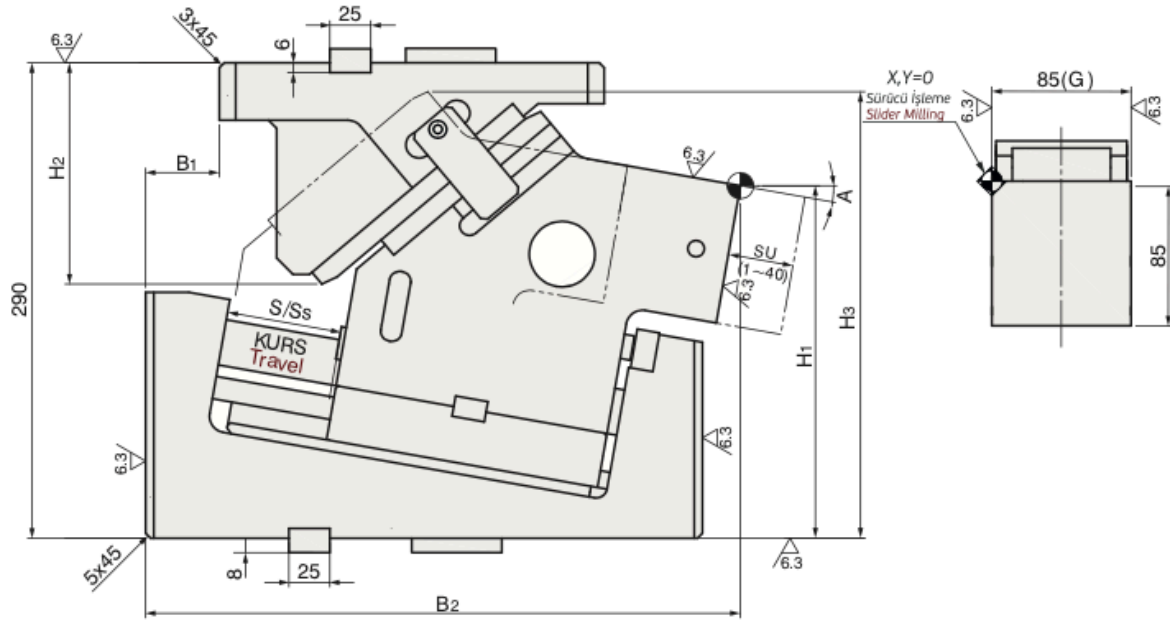
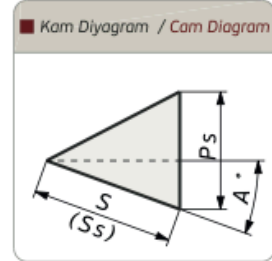
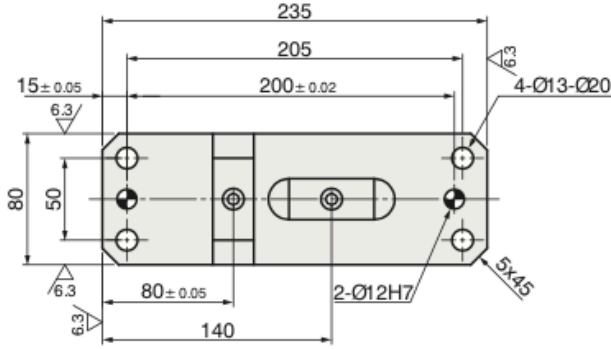
Çalışma Yüzeyi/Mounting Surface		Çalışma Açısı Work Angle (°)	Kam Kuru/Cam Travel Stroke (mm)	Çalışma Kuvveti Working Force	Yay Kuvveti Spring Force	Gazlı Yay Kuvveti Gas Spring Force
(G)	(Gh)	(A)	(S)			
85	85	00	70	1.000.000 Baskı/Stroke 58,8 kN (6,0 tonf)		5880 N (600 kgf)
85	85	05	70			5880 N (600 kgf)
85	85	10	70			5880 N (600 kgf)
85	85	15	70			5880 N (600 kgf)
85	85	20	70			5880 N (600 kgf)



Kam Kodu Cam Kode	Açı Angle (A)	Ölçüler / Dimensions (mm)							
		S	Ps	Ss	H1	H2	H3	B1	B2
AKVS-85	00	70	83,4	108,9	235,0	158,4	258,4	-15	340,0
AKVS-85	05	70	75,8	98,6	225,4	146,6	265,9	-30	354,3
AKVS-85	10	70	70,0	90,0	215,0	134,9	272,4	-45	363,2
AKVS-85	15	70	65,5	82,5	204,9	122,6	278,7	-55	371,6
AKVS-85	20	70	61,9	76,0	195,0	109,6	284,7	-70	379,4

	Kod / Code	(G)	(A)	Opsiyon / Option
	AKVS	85	05	SU