

**AKUSL-900 Bilgilendirme / Information**

- Çalışma Kuvveti / Working Force : (300.000 Baskı/Stroke)614,5 kN(62,7tonf)
- Sürücü Geniřlięi / Slider Width : 900 mm
- Çalışma Açısı / Work Angle : 0° ~ 60°
- Sipariř Örneęi / Order Example : AKUSL-900-55

**Kam Diyagramı / Cam Diagram**

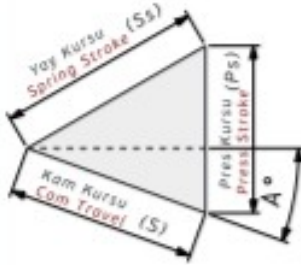

**Sipariř Örneęi / Order Example**

Kam Kodu Cam Code	Sürücü Geniřlięi Slider Width (mm)	Çalışma Açısı Work Angle (°)	Opsiyon Kodu / Option Code			
	(G)	(A)	---	---	---	---
AKUSL -	900	- 15				

**AKUSL-900 Teknik Bilgiler / Technical Informations**

Çalışma Yüzeyi/Mounting Surface		Çalışma Açısı Work Angle (°)	Kam Kuruřu/Cam Travel Stroke (mm)	Çalışma Kuvveti Working Force	Yay Kuvveti Spring Force	Gazlı Yay Kuvveti Gas Spring Force
(G)	(Gh)	(A)	(S)			
900	180	00	38,6	300.000 Baskı/Stroke 614,5 kN (62,7 tonf)		39670 N (4048 kgf)
900	180	05	42,6			39670 N (4048 kgf)
900	180	10	46,7			39670 N (4048 kgf)
900	180	15	50,9			39670 N (4048 kgf)
900	180	20	55,3			39670 N (4048 kgf)
900	180	25	60,0			39670 N (4048 kgf)
900	180	30	65,1			39670 N (4048 kgf)
900	180	35	70,8			39670 N (4048 kgf)
900	180	40	77,1			39670 N (4048 kgf)
900	180	45	84,5			39670 N (4048 kgf)
900	180	50	93,3			39670 N (4048 kgf)
900	180	55	104,6			39670 N (4048 kgf)
900	180	60	120,0			39670 N (4048 kgf)

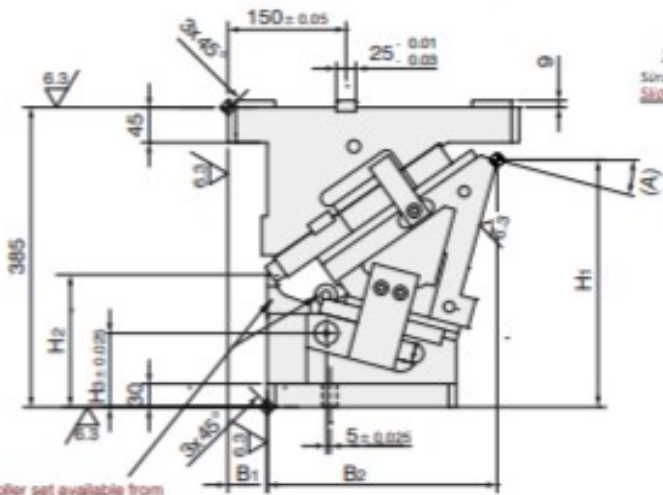
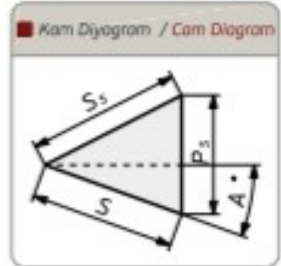
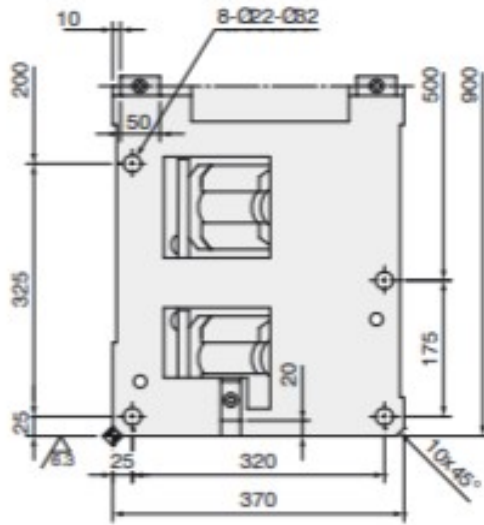

X, Y=0  
Sürücü İşleme  
Slider Aktarma

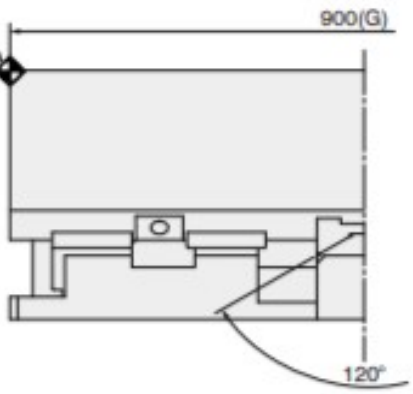

Roller set available from  
0° to 25° working angle

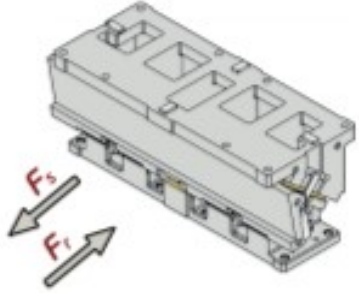
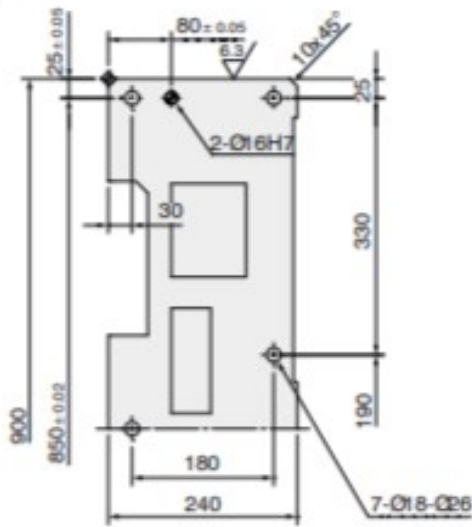

Kam Kodu Cam Kode	Açı Angle (A)	Ölçüler / Dimensions (mm)							
		S	P <sub>s</sub>	S <sub>s</sub>	H <sub>1</sub>	H <sub>2</sub>	H <sub>3</sub>	B <sub>1</sub>	B <sub>2</sub>
AKUSL-900	00	38,6	46,0	60	328,0	115,0	55	95	228,0
AKUSL-900	05	42,6	46,1	60	326,4	132,0	70	80	249,6
AKUSL-900	10	46,7	46,7	60	322,8	145,0	80	65	270,9
AKUSL-900	15	50,9	47,6	60	317,5	170,0	95	50	291,9
AKUSL-900	20	55,3	48,9	60	310,3	182,0	110	35	312,3
AKUSL-900	25	60,0	50,7	60	301,4	210,0	120	15	332,1
AKUSL-900	30	65,1	53,1	60	280,8	219,0	125	0	350,9
AKUSL-900	35	70,8	56,1	60	268,6	190,3	135	-15	368,8
AKUSL-900	40	77,1	60,0	60	254,8	198,7	150	-30	385,5
AKUSL-900	45	84,5	65,0	60	239,7	207,8	160	-40	401,0
AKUSL-900	50	93,3	71,5	60	223,3	215,0	160	-60	415,1
AKUSL-900	55	104,6	85,7	60	205,7	218,3	180	-60	427,7
AKUSL-900	60	120,0	103,9	60	187,1	225,2	185	-60	439,1

 <b>Kod / Code</b>	<b>(G)</b>	<b>(A)</b>
AKUSL	900	30