

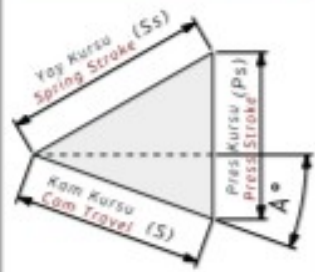

**AKUNR-80 Bilgilendirme / Information**

- Çalışma Kuvveti / Working Force : (300.000 Baskı/Stroke)166,6 kN(17,0tonf)
- Sürücü Genişliği / Slider Width : 80 mm
- Çalışma Açısı / Work Angle : 0° - 60°
- Gazlı Yay Opsiyon / Gas Spring Option : GY
- Pim Deliği F13 (Opsiyon) / Dowel Pin F13 (Option)
- Sipariş Örneği / Order Example : AKUNR-80-15-GY-F13

**Kam Diyagram / Cam Diagram**



**Sipariş Örneği / Order Example**

Kam Kodu Cam Code	Sürücü Genişliği Slider Width ömm	Çalışma Açısı Work Angle °)	Opsiyon Kodu / Option Code			
			Gazlı Yay Gas Spring	Pim Deliği Dowel Pin	---	---
AKUNR - 80 - 00						
AKUNR - 80 - 50 - GY						
AKUNR - 80 - 50 - GY - F13						

**AKUNR-80 Teknik Bilgiler / Technical Informations**

Çalışma Yüzeyi/Mounting Surface		Çalışma Açısı Work Angle (°)	Kam Kursu/Cam Travel Stroke (mm)	Çalışma Kuvveti Working Force	Yay Kuvveti Spring Force	Gazlı Yay Kuvveti Gas Spring Force (Opsiyon/Option)
(G)	(Gh)					
80	75	00	32,1	300.000 Baskı/Stroke 166,6 kN (17,0 tonf)	1225 N (125 kgf)	2352 N (240 kgf)
80	75	05	35,5		1225 N (125 kgf)	2352 N (240 kgf)
80	75	10	38,9		1225 N (125 kgf)	2352 N (240 kgf)
80	75	15	42,4		1225 N (125 kgf)	2352 N (240 kgf)
80	75	20	46,1		1225 N (125 kgf)	2352 N (240 kgf)
80	75	25	50,0		1225 N (125 kgf)	2352 N (240 kgf)
80	75	30	54,3		1225 N (125 kgf)	2352 N (240 kgf)
80	75	35	59,0		1225 N (125 kgf)	2352 N (240 kgf)
80	75	40	64,3		1225 N (125 kgf)	2352 N (240 kgf)
80	75	45	70,4		1225 N (125 kgf)	2352 N (240 kgf)
80	75	50	77,8		1225 N (125 kgf)	2352 N (240 kgf)
80	75	55	78,5		1107 N (113 kgf)	2352 N (240 kgf)
80	75	60	80,0		990 N (101 kgf)	2352 N (240 kgf)

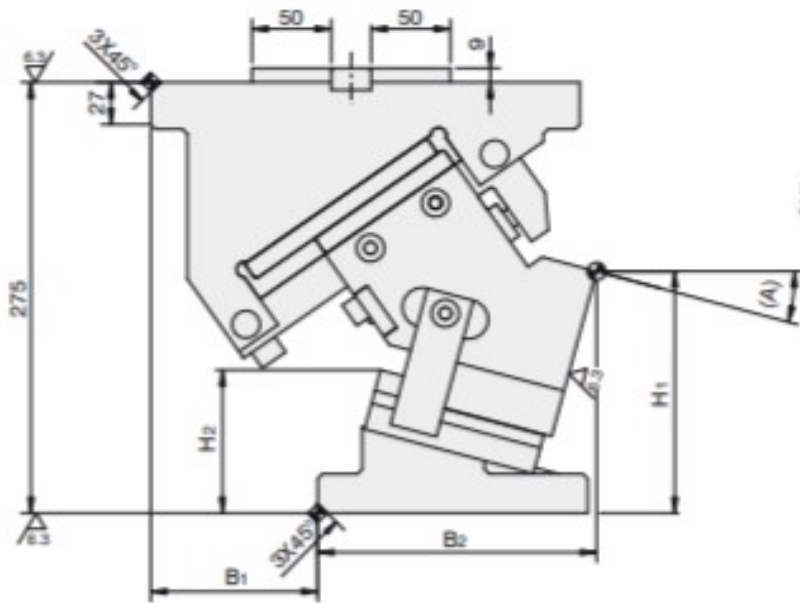
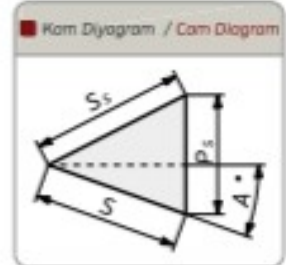
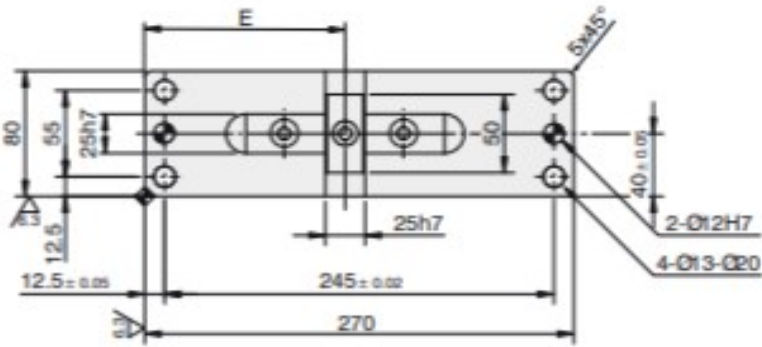

$X, Y=0$   
Sırtıcı İşleme  
Slider Mekanizması

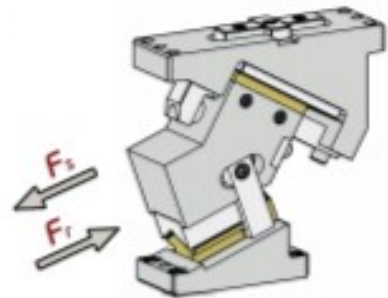
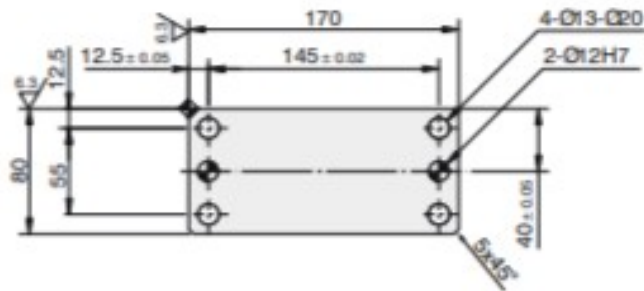
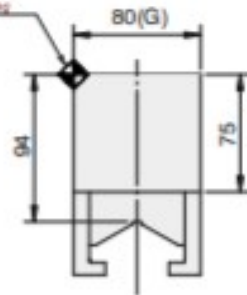

Kam Kodu Cam Kode	Açı Angle (A)	Ölçüler / Dimensions (mm)							
		S	P <sub>s</sub>	S <sub>s</sub>	H <sub>1</sub>	H <sub>2</sub>	B <sub>1</sub>	B <sub>2</sub>	E
AKUNR-80	00	32,1	38,3	50	165,0	69,0	135	145,0	99,50
AKUNR-80	05	35,5	38,4	50	159,1	73,5	125	156,3	116,50
AKUNR-80	10	38,9	38,9	50	157,2	82,6	110	167,5	115,87
AKUNR-80	15	42,4	39,7	50	154,3	91,3	105	174,7	123,20
AKUNR-80	20	46,1	40,8	50	150,5	99,6	95	181,2	121,57
AKUNR-80	25	50,0	42,3	50	145,7	107,3	80	191,5	121,07
AKUNR-80	30	54,3	44,2	50	140,1	114,5	65	199,3	116,77
AKUNR-80	35	59,0	46,8	50	133,8	120,9	55	205,7	116,26
AKUNR-80	40	64,3	50,0	50	127,2	126,8	35	217,3	110,84
AKUNR-80	45	70,4	54,2	50	118,4	131,8	30	217,5	109,54
AKUNR-80	50	77,8	59,6	50	109,7	136,1	15	222,8	103,62
AKUNR-80	55	78,5	64,3	45	100,5	139,6	0	231,4	117,12
AKUNR-80	60	80,0	69,3	40	89,1	140,7	0	234,0	116,03

 <b>ORDER</b>	Kod / Code	(G)	(A)	Opsiyon / Option
	AKUNR	80	30	GY - F13