

**AKUNR-70 Bilgilendirme / Information**

- Çalışma Kuvveti / Working Force : (300.000 Baskı/Stroke) 98,0 kN(10,0 tonf)
- Sürücü Genişliği / Slider Width : 70 mm
- Çalışma Açısı / Work Angle : 0° – 60°
- Gazlı Yay Opsiyon / Gas Spring Option : GY
- Sipariş Örneği / Order Example : AKUNR-70-40-GY

**Kam Diyagramı / Cam Diagram**

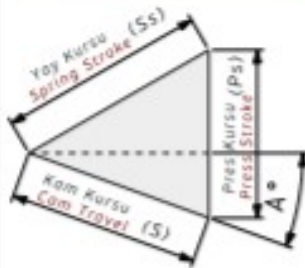

**Sipariş Örneği / Order Example**

Kam Kodu Cam Code	Sürücü Genişliği Slider Width (mm)	Çalışma Açısı Work Angle (°)	Opsiyon Kodu / Option Code		
	(G)	(A)	Gazlı Yay Gas Spring	---	---
AKUNR -	70	- 00			
AKUNR -	70	- 25	- GY		

**AKUNR-70 Teknik Bilgiler / Technical Informations**

Çalışma Yüzeyi/Mounting Surface		Çalışma Açısı Work Angle (°)	Kam Kuruşu/Cam Travel Stroke (mm)	Çalışma Kuvveti Working Force	Yay Kuvveti Spring Force	Gazlı Yay Kuvveti Gas Spring Force (Opsiyon/Option)
(G)	(Gh)	(A)	(S)			
70	75	00	19,3	300.000 Baskı/Stroke 98,0 kN (10,0 tonf)	657 N (67 kgf)	2352 N (240 kgf)
70	75	05	21,3		657 N (67 kgf)	2352 N (240 kgf)
70	75	10	23,3		657 N (67 kgf)	2352 N (240 kgf)
70	75	15	25,4		657 N (67 kgf)	2352 N (240 kgf)
70	75	20	27,6		657 N (67 kgf)	2352 N (240 kgf)
70	75	25	30,0		657 N (67 kgf)	2352 N (240 kgf)
70	75	30	32,6		657 N (67 kgf)	2352 N (240 kgf)
70	75	35	35,4		657 N (67 kgf)	2352 N (240 kgf)
70	75	40	38,6		657 N (67 kgf)	2352 N (240 kgf)
70	75	45	42,3		657 N (67 kgf)	2352 N (240 kgf)
70	75	50	46,7		657 N (67 kgf)	2352 N (240 kgf)
70	75	55	43,6		657 N (67 kgf)	2352 N (240 kgf)
70	75	60	50,0		657 N (67 kgf)	2352 N (240 kgf)

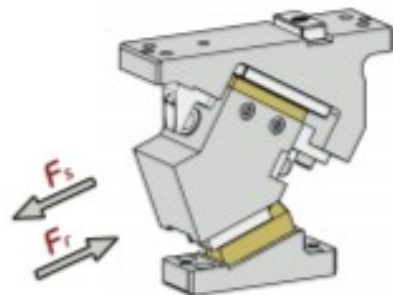
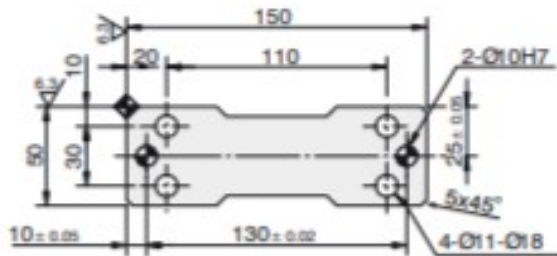
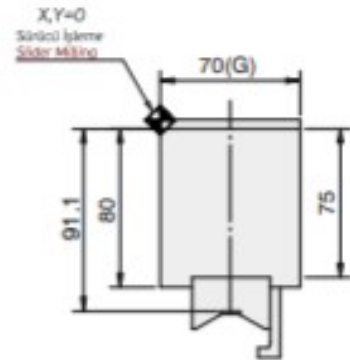
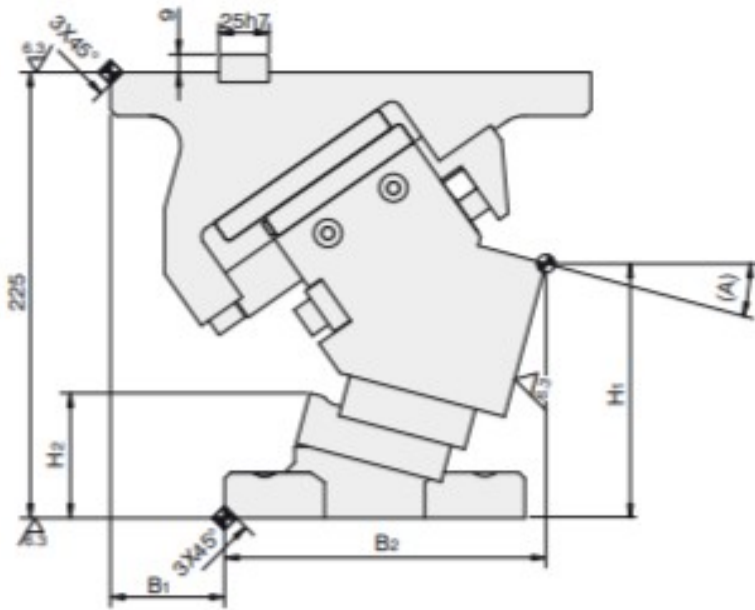
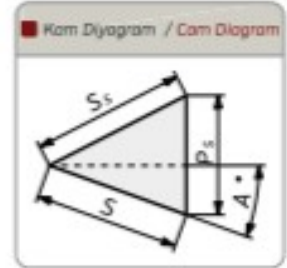
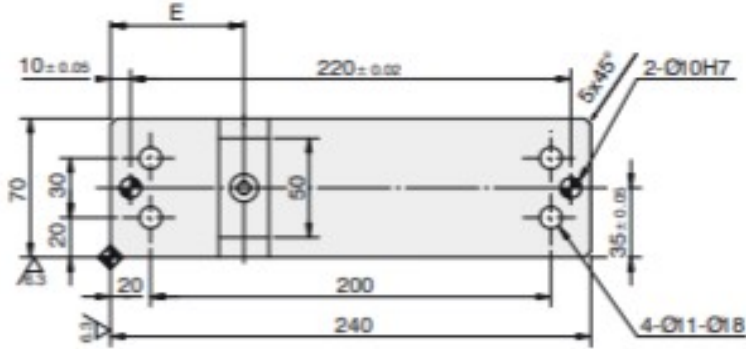

Kam Kodu Cam Kode	Açı Angle (A)	Ölçüler / Dimensions (mm)							
		S	Ps	Ss	H1	H2	B1	B2	E
AKUNR-70	00	19,3	22,9	30	140,0	46,4	102	135,37	81,37
AKUNR-70	05	21,3	23,1	30	138,7	53,9	92	142,87	81,53
AKUNR-70	10	23,3	23,3	30	136,2	60,9	81	151,82	80,24
AKUNR-70	15	25,4	23,8	30	128,4	63,1	57	160,50	66,67
AKUNR-70	20	27,6	24,5	30	125,4	70,5	52	172,50	75,62
AKUNR-70	25	30,0	25,4	30	119,6	75,7	42	181,50	75,76
AKUNR-70	30	32,6	26,5	30	112,0	79,4	30	181,60	66,03
AKUNR-70	35	35,4	28,1	30	107,8	86,8	17	193,70	66,86
AKUNR-70	40	38,6	30,0	30	99,9	90,6	4	200,90	63,69
AKUNR-70	45	42,3	32,5	30	93,7	96,1	-2	200,20	58,40
AKUNR-70	50	46,7	35,8	30	89,9	104,0	-21	212,00	49,59
AKUNR-70	55	43,6	35,7	25	79,0	104,8	-23	213,50	56,02
AKUNR-70	60	50,0	43,3	25	69,1	106,3	-35	220,80	56,99

 <b>Kod / Code</b>	<b>(G)</b>	<b>(A)</b>	<b>Opsiyon / Option</b>
AKUNR	70	20	GY