

AKUC-150 Bilgilendirme / Information

- Çalışma Kuvveti / Working Force : (300.000 Baskı/Stroke) 132,3kN(13,5tonf)
- Sürücü Geniřliđi / Slider Width : 150 mm
- Çalışma Açısı / Work Angle : 0° – 70°
- Gazlı Yay Opsiyonu / Gas Spring Option : GY
- Sürtünme Plakası Opsiyonu / Wear Plate Option : P
- Pim Deliđi Ø13H7-Ø16H7 (Opsiyon) / Dowel Pin Ø13H7-Ø16H7 (Option)
- Sipariř Örneđi / Order Example : AKUC-150-00-P-GY

Kam Diyagramı / Cam Diagram

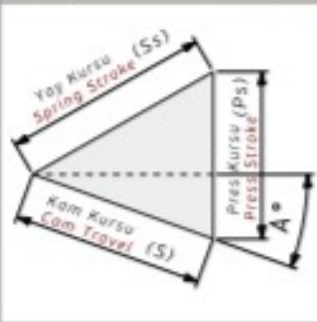

Sipariř Örneđi / Order Example

Kam Kodu Cam Code	Sürücü Geniřliđi Slider Width (mm)	Çalışma Açısı Work Angle (°)	Opsiyon Kodu / Option Code			
			Sürtünme Plakası Wear Plate	Gazlı Yay Gas Spring	Pim Deliđi Dowel Pin	---
AKUC - 150 - 00						
AKUC - 150 - 20 - P - GY						
AKUC - 150 - 50 - P - GY - F16						

AKUC-150 Teknik Bilgiler / Technical Informations

Çalışma Yüzeyi/Mounting Surface		Çalışma Açısı Work Angle (°)	Kam Kursu/Cam Travel Stroke (mm)	Çalışma Kuvveti Working Force	Yay Kuvveti Spring Force	Gazlı Yay Kuvveti Gas Spring Force (Opsiyon/Option)
(G)	(Gh)	(A)	(S)			
150	85	00	32,1	300.000 Baskı/Stroke 132,3 kN (13,5 tonf)	4607 N (470 kgf)	8134 N (830 kgf)
150	85	05	32,3		4607 N (470 kgf)	8134 N (830 kgf)
150	85	10	38,9		4607 N (470 kgf)	8134 N (830 kgf)
150	85	15	39,7		4607 N (470 kgf)	8134 N (830 kgf)
150	85	20	46,1		4607 N (470 kgf)	8134 N (830 kgf)
150	85	25	47,8		4607 N (470 kgf)	8134 N (830 kgf)
150	85	30	54,3		4607 N (470 kgf)	8134 N (830 kgf)
150	85	35	57,4	1.000.000 Baskı/Stroke 88,2 kN (9,0 tonf)	4607 N (470 kgf)	8134 N (830 kgf)
150	85	40	64,3		4607 N (470 kgf)	8134 N (830 kgf)
150	85	45	69,6		4607 N (470 kgf)	8134 N (830 kgf)
150	85	50	77,8		4607 N (470 kgf)	8134 N (830 kgf)
150	85	55	87,2		4607 N (470 kgf)	8134 N (830 kgf)
150	85	60	98,5		4607 N (470 kgf)	8134 N (830 kgf)
150	85	65	93,2		4607 N (470 kgf)	8134 N (830 kgf)
150	85	70	86,4	4607 N (470 kgf)	8134 N (830 kgf)	

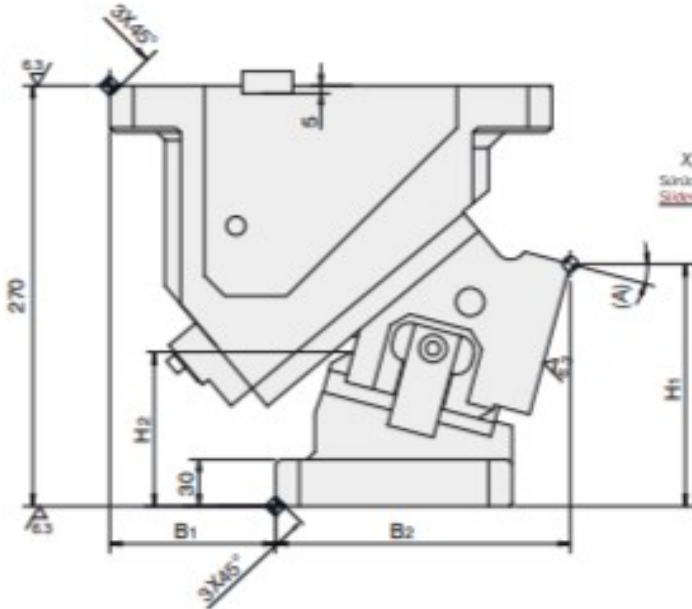
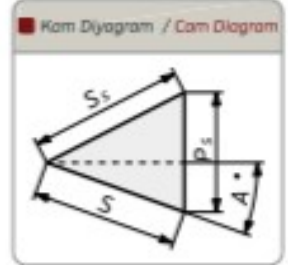
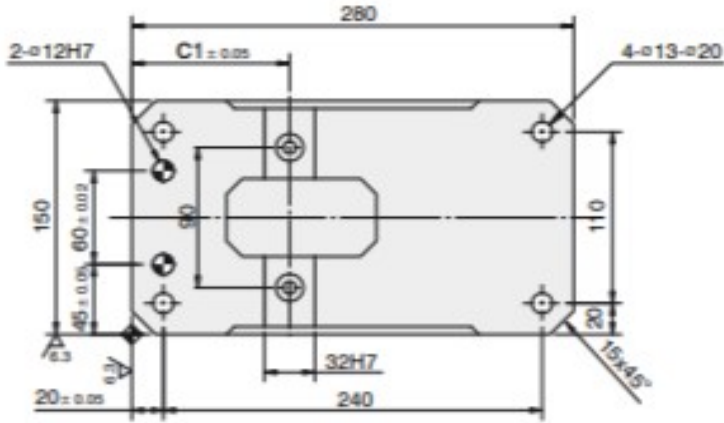

X, Y=0
Sürücü İlemler
Sürekli Mühür

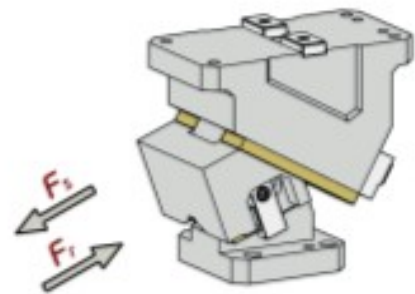
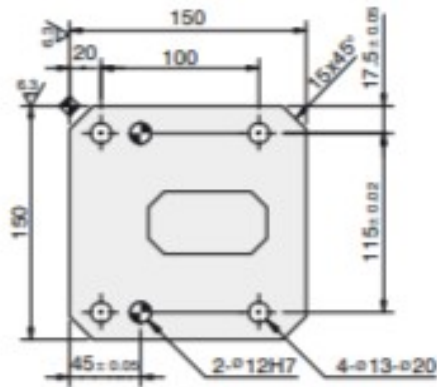
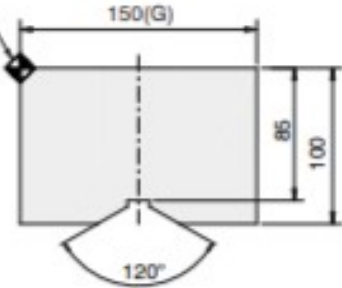

Kam Kodu Cam Kode	Açı Angle (A)	Ölçüler / Dimensions (mm)							
		S	P _s	S _s	H ₁	H ₂	B ₁	B ₂	c ₁
AKUC-150	00	32,1	38,3	50	185,0	94,0	120	160,0	100
AKUC-150	05	32,3	41,1	50	174,2	94,0	115	173,3	100
AKUC-150	10	38,9	38,9	50	167,6	98,9	105	180,5	100
AKUC-150	15	39,7	42,4	50	155,5	98,7	105	186,8	100
AKUC-150	20	46,1	40,8	50	147,9	103,5	90	197,0	135
AKUC-150	25	47,8	45,2	50	134,9	103,2	90	201,0	135
AKUC-150	30	54,3	44,2	50	131,6	112,8	70	213,9	135
AKUC-150	35	57,4	50,0	50	118,1	112,4	70	215,7	135
AKUC-150	40	64,3	50,0	50	114,5	121,9	45	231,2	170
AKUC-150	45	69,6	57,9	50	100,9	121,4	45	230,6	170
AKUC-150	50	77,8	59,6	50	102,4	137,0	25	238,7	170
AKUC-150	55	87,2	71,4	50	89,1	137,6	25	235,7	170
AKUC-150	60	98,5	76,6	50	76,1	138,2	0	246,6	170
AKUC-150	65	93,2	77,5	40	63,5	138,6	0	241,4	170
AKUC-150	70	86,4	76,0	30	51,4	141,9	-5	245,0	170

 Kod / Code	(G)	(A)	Opsiyon / Option
 ORDER AKUC	150	35	F13/F16 - P - GY

