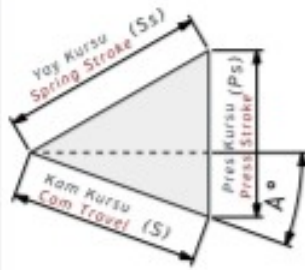

AKSNC-65 Bilgilendirme / Information

- Çalışma Kuvveti / Working Force : (300.000 Baskı/Stroke) 14,6 kN (3,0tonf)
- Sürücü Geniřlięi / Slider Width : 65 mm
- Çalışma Açısı / Work Angle : 0° ~ 25°
- Gazlı Yay Opsiyon / Gas Spring Option : GY
- SU Opsiyonu / SU Option : 1-60 mm
- Sürtünme Plakası Opsiyonu / Wear Plate Option : P
- Pim Delięi Ø12H7 (Opsiyon F13) / Dowel Pin Ø12H7 (Option F13)
- Sipariř Örneęi / Order Example : AKSNC-65-10-SU150

Kam Diyagram / Cam Diagram

Sipariř Örneęi / Order Example

Kam Kodu Cam Code	Sürücü Geniřlięi Slider Width (mm)	Çalışma Açısı Work Angle (°)	Opsiyon Kodu / Option Code			
			Sürücü Uzunluęu Slider Length	Sürtünme Plakası Wear Plate	Gazlı Yay Gas Spring	Pim Delięi Dowel Pin
AKSNC - 65 - 00						
AKSNC - 65 - 15 - SU100						
AKSNC - 65 - 15 - SU80 - P - GY - F13						

AKSNC-65 Teknik Bilgiler / Technical Informations

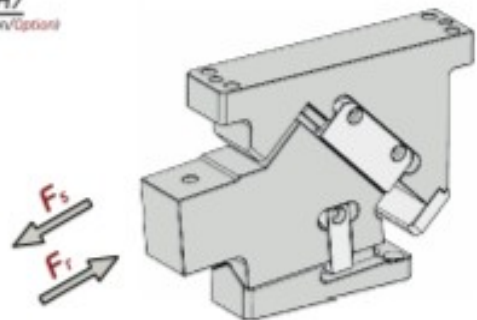
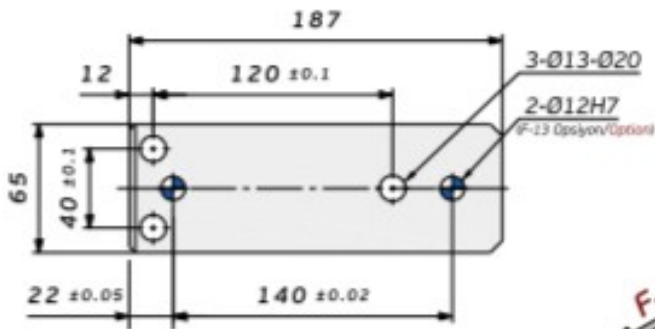
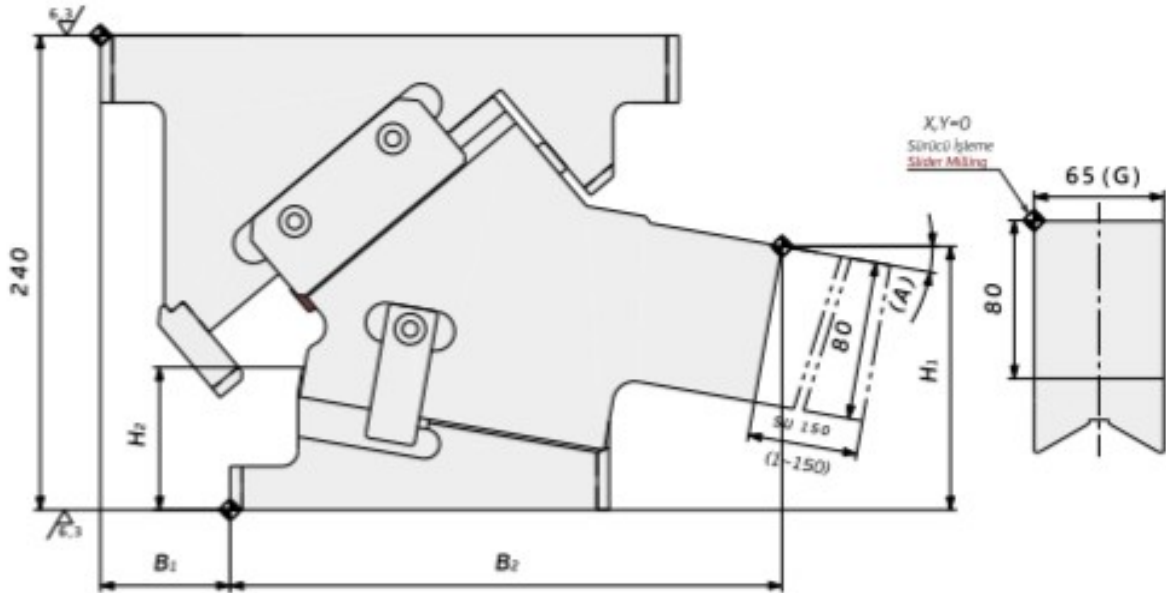
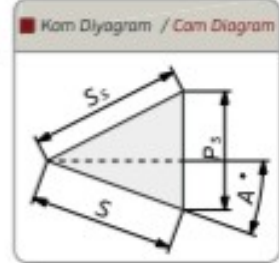
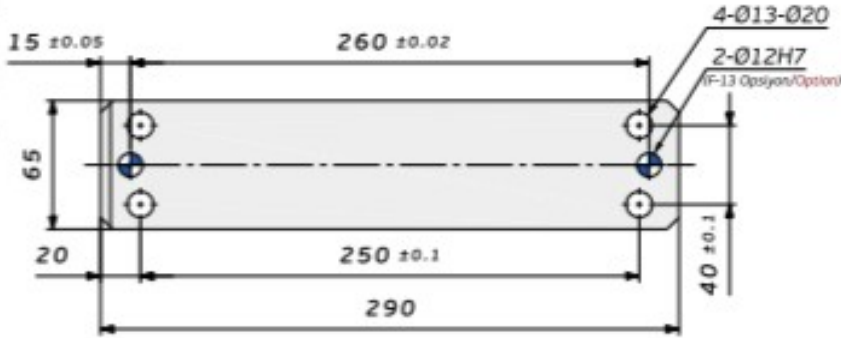
Çalışma Yüzeyi/Mounting Surface		Çalışma Açısı Work Angle (°)	Kam Kuruřu/Cam Travel Stroke (mm)	Çalışma Kuvveti Working Force	Yay Kuvveti Spring Force	Gazlı Yay Kuvveti Gas Spring Force (Opsiyon/Option)
(G)	(Gh)					
65	80	00	30,1	300.000 Baskı/Stroke 14,6 kN (1,5 tonf)	2820 N (290kgf)	6070 N (618kgf)
65	80	05	31,8		2820 N (290kgf)	5952 N (607kgf)
65	80	10	35,0		2820 N (290kgf)	5952 N (607kgf)
65	80	15	31,3		2820 N (290kgf)	5305 N (541kgf)
65	80	20	32,2		2820 N (290kgf)	5432 N (554kgf)
65	80	25	35,0		2820 N (290kgf)	5432 N (554kgf)



Kam Kodu Cam Kode	Açı Angle (A)	Ölçüler / Dimensions (mm)						
		S	P _s	S _s	H ₁	H ₂	B ₁	B ₂
AKSNC-65	00	30,2	36,0	47	147,00	47,0	75	260,00
AKSNC-65	05	31,9	34,6	45	140,51	58,6	70	268,62
AKSNC-65	10	35,0	35,0	45	133,30	72,3	65	276,65
AKSNC-65	15	31,4	23,9	37	125,41	86,5	55	284,01
AKSNC-65	20	32,3	28,5	35	106,91	91,4	45	290,66
AKSNC-65	25	35,0	29,6	35	97,86	102,4	35	296,55

 ORDER	Kod / Code	(G)	(A)	Opsiyon / Option
	AKSNC	65	15	F13