

AKKSL-700 Bilgilendirme / Information

- Çalışma Kuvveti / Working Force : (300.000 Baskı/Stroke)470,4 kN(48,0tonf)
- Sürücü Genişliği / Slider Width : 700 mm
- Çalışma Açısı / Work Angle : 0°~20°
- Sipariş Örneği / Order Example : AKKSL-700-00

Kam Diyagramı / Cam Diagram

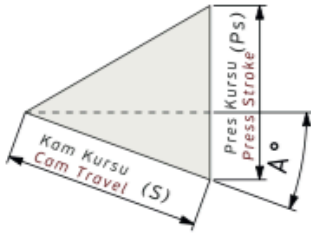

Sipariş Örneği / Order Example

Kam Kodu Cam Code	Sürücü Genişliği Slider Width (mm)	Çalışma Açısı Work Angle (°)	Opsiyon Kodu / Option Code			
	(G)	(A)	---	---	---	---
AKKSL -	700	- 20				

AKKSL-700 Teknik Bilgiler / Technical Informations

Çalışma Yüzeyi/Mounting Surface		Çalışma Açısı Work Angle (°)	Kam Kuru/Cam Travel Stroke (mm)	Çalışma Kuvveti Working Force	Yay Kuvveti Spring Force	Gazlı Yay Kuvveti Gas Spring Force
(G)	(Gh)	(A)	(S)			
700	180	00	60	300.000 Baskı/Stroke 470,4 kN (48,0 tonf)		44100 N (4500 kgf)
700	180	05	60			44100 N (4500 kgf)
700	180	10	60			44100 N (4500 kgf)
700	180	15	60			44100 N (4500 kgf)
700	180	20	60			44100 N (4500 kgf)

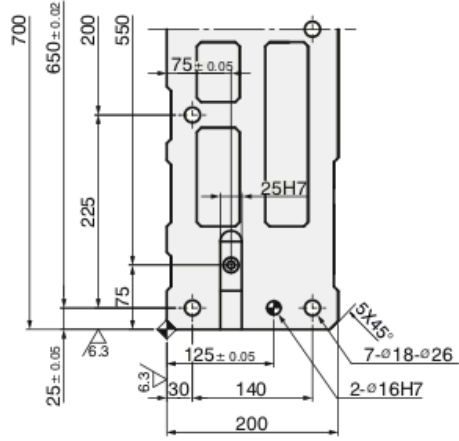

■ Kam Diyogram / Cam Diagram

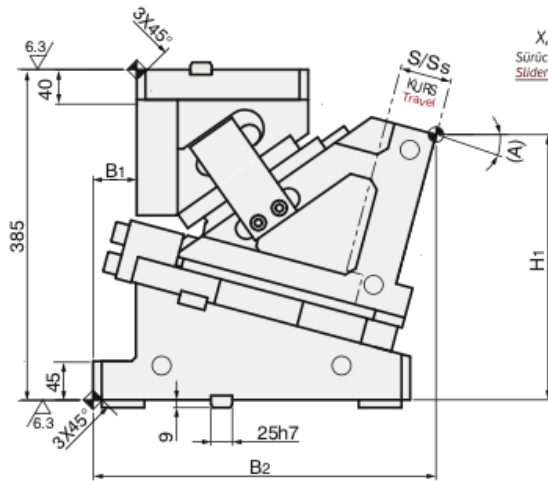
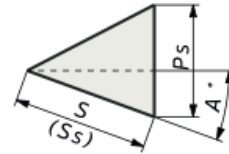

X,Y=0
Sürücü İşleme
Slider Milling

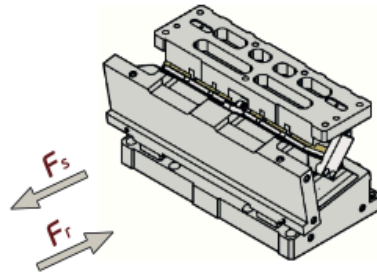
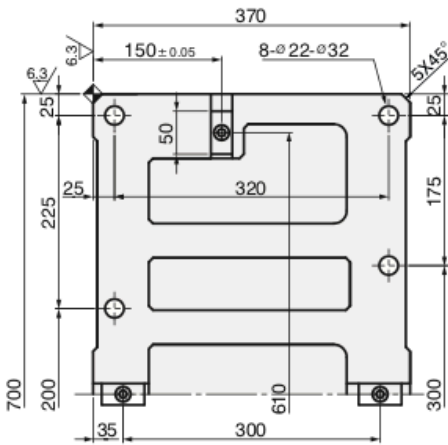
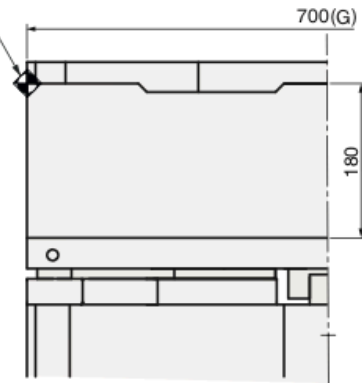

Kam Kodu Cam Kode	Açı Angle (A)	Ölçüler / Dimensions (mm)					
		S	P _s	S _s	B ₁	B ₂	H ₁
AKKSL-700	00	60	71,5	60	-6	350,0	360,0
AKKSL-700	05	60	65,0	60	-21	368,2	343,3
AKKSL-700	10	60	60,0	60	-36	385,0	326,3
AKKSL-700	15	60	56,1	60	-51	400,2	309,3
AKKSL-700	20	60	53,1	60	-66	414,0	292,3

 Kod / Code	(G)	(A)
 ORDER AKKSL	700	05