

AKHV-400 Bilgilendirme / Information

- Çalışma Kuvveti / Working Force : (300.000 Baskı/Stroke) 1050 kN(108 tonf)
- Sürücü Genişliği / Slider Width : 400 mm
- Çalışma Açısı / Work Angle : 0° - 75°
- Sipariş Örneği / Order Example : AKHV-400-30

Kam Diyagramı / Cam Diagram

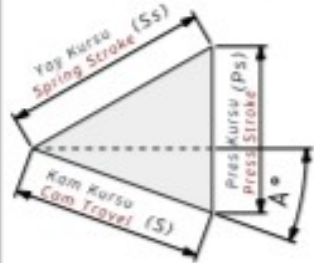

Sipariş Örneği / Order Example

Kam Kodu Cam Code	Sürücü Genişliği Slider Width (mm)	Çalışma Açısı Work Angle (°)	Opsiyon Kodu / Option Code			
	(G)	(A)	---	---	---	---
AKHV	- 400	- 60				

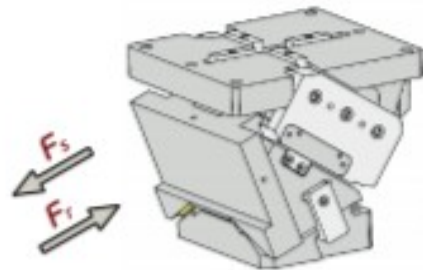
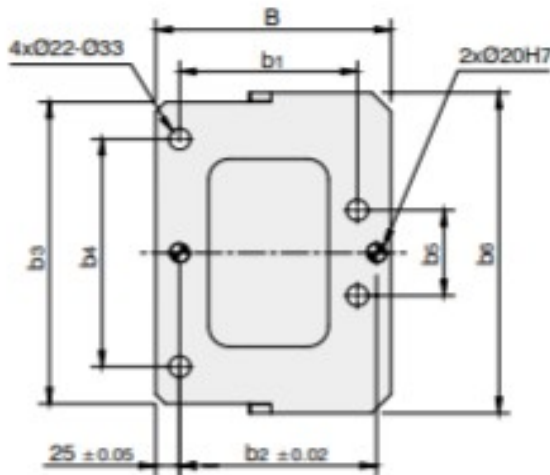
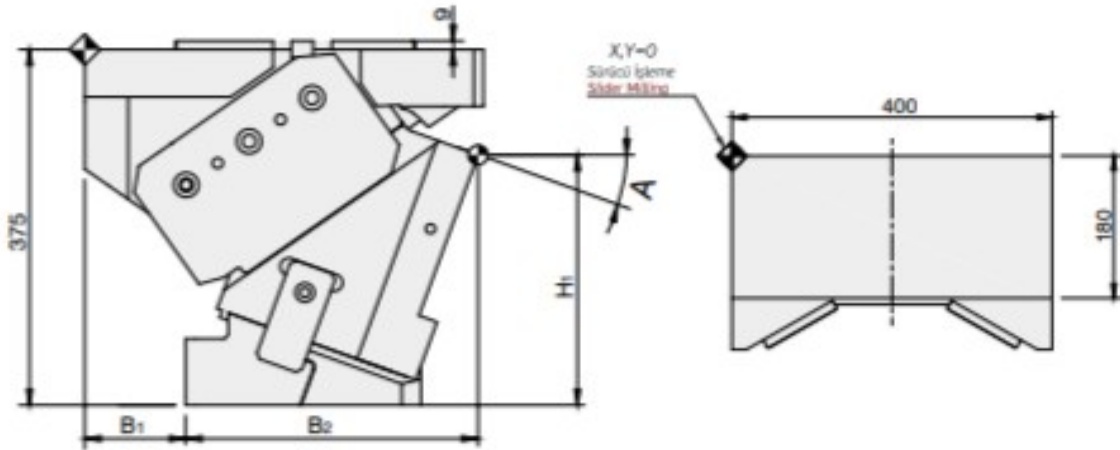
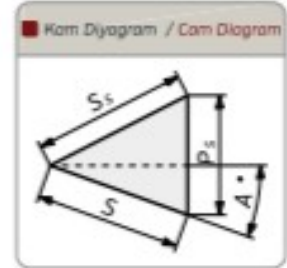
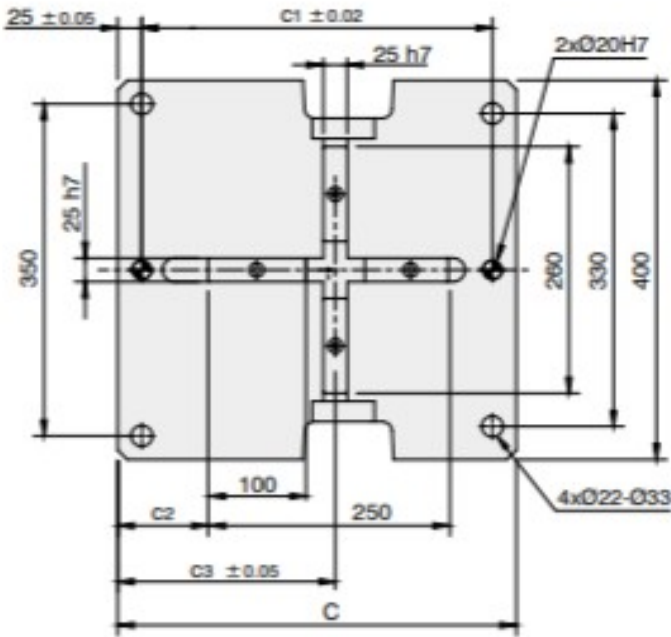

AKHV-400 Teknik Bilgiler / Technical Informations

Çalışma Yüzeyi/Mounting Surface		Çalışma Açısı Work Angle (°)	Kam Kuruşu/Cam Travel Stroke (mm)	Çalışma Kuvveti Working Force	Yay Kuvveti Spring Force	Gazlı Yay Kuvveti Gas Spring Force
(G)	(Gh)	(A)	(S)			
400	180	00	37,3	300.000 Baskı/Stroke 1050,0 kN (108,0 tonf)		63700 N (6500 kgf)
400	180	05	41,2			66640 N (6800 kgf)
400	180	10	41,6			69580 N (7100 kgf)
400	180	15	46,0			70756 N (7220 kgf)
400	180	20	50,6			72128 N (7360 kgf)
400	180	25	52,4			73598 N (7510 kgf)
400	180	30	58,0			76244 N (7780 kgf)
400	180	35	61,3			77028 N (7860 kgf)
400	180	40	68,6			78302 N (7990 kgf)
400	180	45	74,3			79184 N (8080 kgf)
400	180	50	84,8			83006 N (8470 kgf)
400	180	55	95,0			84182 N (8590 kgf)
400	180	60	112,0			88690 N (9050 kgf)
400	180	65	102,9			89964 N (9180 kgf)
400	180	70	127,1			90160 N (9200 kgf)
400	180	75	114,2			98000 N (10000 kgf)



Kam Kodu Cam Kode	Açı Angle (A)	Ölçüler / Dimensions (mm)								
		S	P _s	S _s	H ₁	B	B ₁	B ₂	b ₁	b ₂
AKHV-400	00	37,3	44,4	58	300,0	280	130	273,0	185	205
AKHV-400	05	41,2	44,6	58	280,7	280	130	280,9	185	205
AKHV-400	10	41,6	48,2	58	275,7	255	130	288,8	185	205
AKHV-400	15	46,0	49,2	58	270,0	255	130	296,7	185	205
AKHV-400	20	50,6	50,6	58	263,7	245	105	329,5	185	205
AKHV-400	25	52,4	55,4	58	256,6	260	80	337,2	145	175
AKHV-400	30	58,0	58,0	58	243,9	250	80	344,6	145	175
AKHV-400	35	61,3	64,2	58	224,9	237	80	347,8	145	175
AKHV-400	40	68,6	68,6	58	216,7	230	80	358,7	145	175
AKHV-400	45	74,3	77,1	58	202,1	225	30	365,2	145	175
AKHV-400	50	84,8	84,8	58	186,7	215	30	382,7	145	175
AKHV-400	55	95,0	97,7	58	162,9	226	30	393,2	145	175
AKHV-400	60	112,0	112,0	58	142,9	230	30	403,6	145	175
AKHV-400	65	102,9	104,9	45	132,4	242	0	434,6	140	175
AKHV-400	70	127,1	131,1	45	120,5	226	0	429,9	125	175
AKHV-400	75	114,2	115,5	30	112,5	214	0	418,5	105	160

Kam Kodu Cam Kode	Açı Angle (A)	Ölçüler / Dimensions (mm)							
		b ₃	b ₄	b ₅	b ₆	C	c ₁	c ₂	c ₃
AKHV-400	00	318	240	90	338	415	365	72,0	209,5
AKHV-400	05	318	240	90	338	415	365	82,5	220,0
AKHV-400	10	318	240	90	338	415	365	93,0	230,5
AKHV-400	15	318	240	90	338	415	365	103,5	241,0
AKHV-400	20	318	240	90	338	415	365	94,0	226,5
AKHV-400	25	318	240	90	338	415	365	104,5	237,0
AKHV-400	30	318	240	90	338	415	365	95,0	247,5
AKHV-400	35	318	240	90	338	415	365	104,0	256,5
AKHV-400	40	318	240	90	338	415	365	98,0	265,5
AKHV-400	45	318	240	90	338	450	401	62,0	224,5
AKHV-400	50	318	240	90	338	450	401	56,0	233,5
AKHV-400	55	318	240	90	338	450	401	63,4	240,9
AKHV-400	60	318	240	90	338	450	401	71,0	248,5
AKHV-400	65	400	363	363	400	450	401	71,0	248,5
AKHV-400	70	400	363	363	400	450	401	71,0	248,5
AKHV-400	75	400	363	363	400	450	401	56,0	233,5

 Kod / Code	(G)	(A)
 ORDER	AKHV	400
		75