

AKHV-150 Bilgilendirme / Information

- Çalışma Kuvveti / Working Force : (300.000 Baskı/Stroke) 480 kN (49 tonf)
- Sürücü Geniřliđi / Slider Width : 150 mm
- Çalışma Açısı / Work Angle : 0° – 75°
- Sipariř Örneđi / Order Example : AKHV-150-45

Kam Diyagramı / Cam Diagram

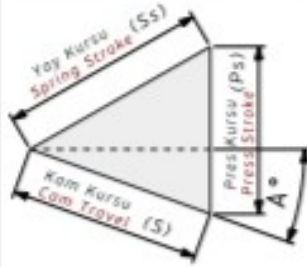

Sipariř Örneđi / Order Example

Kam Kodu Cam Code	Sürücü Geniřliđi Slider Width (mm)	Çalışma Açısı Work Angle (°)	Opsiyon Kodu / Option Code			
	(G)	(A)	---	---	---	---
AKHV	150	00				

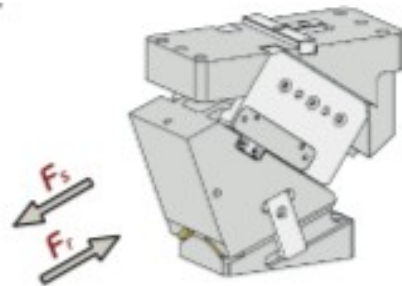
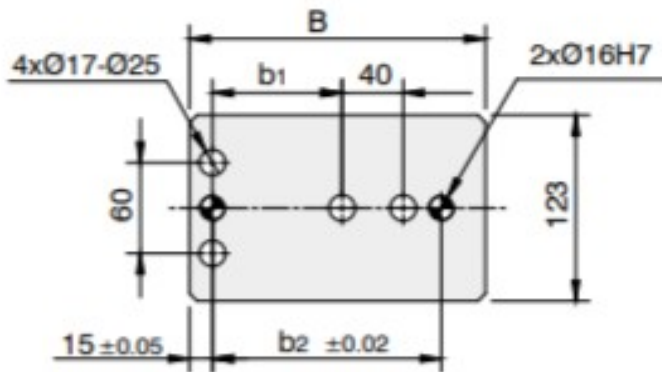
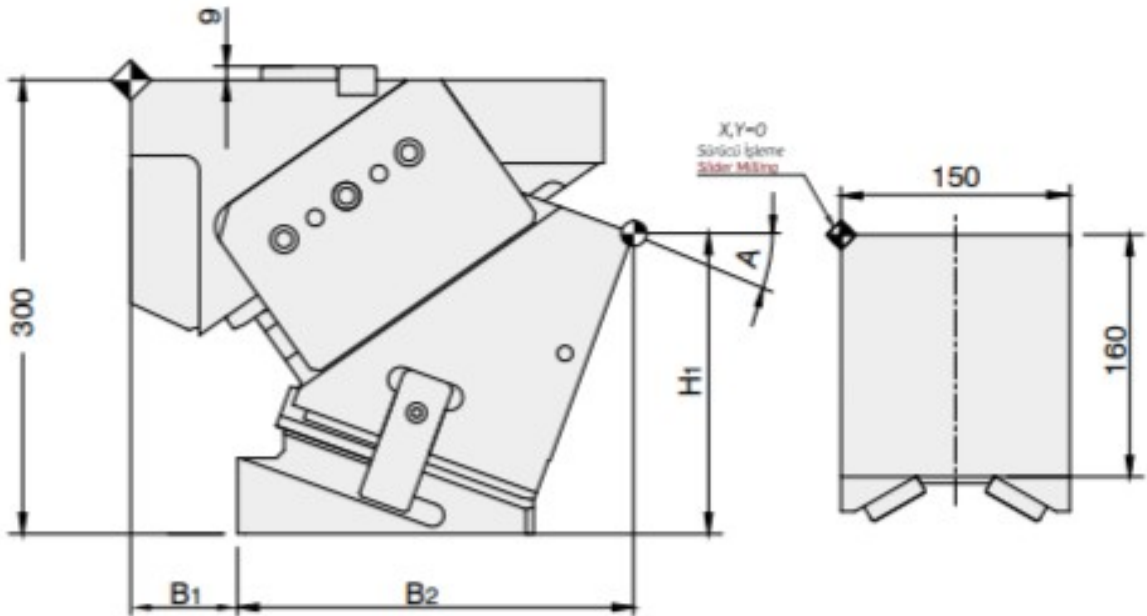
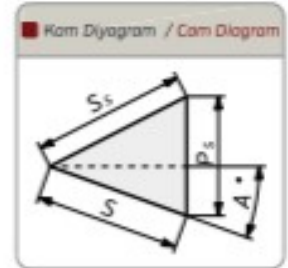
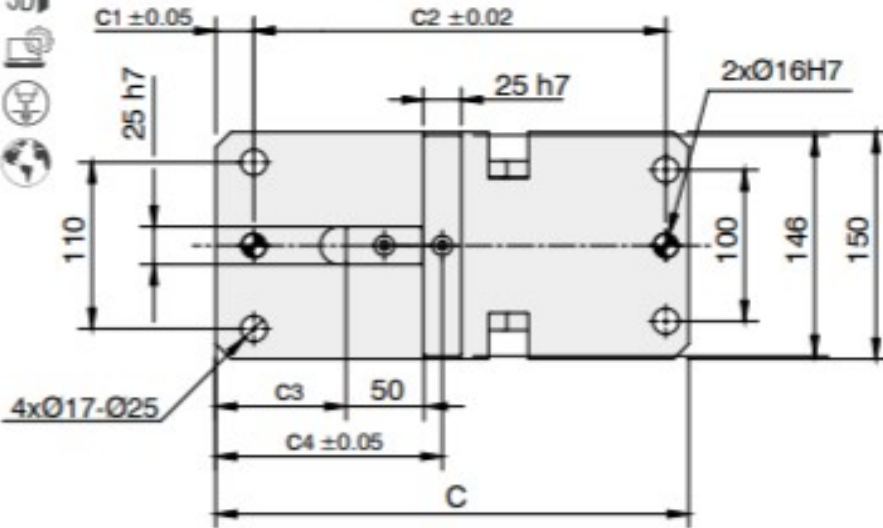

AKHV-150 Teknik Bilgiler / Technical Informations

Çalışma Yüzeyi/Mounting Surface		Çalışma Açısı Work Angle (°)	Kam Kuruřu/Cam Travel Stroke (mm)	Çalışma Kuvveti Working Force	Yay Kuvveti Spring Force	Gazlı Yay Kuvveti Gas Spring Force
(G)	(Gh)	(A)	(S)			
150	160	00	32,1	300.000 Baskı/Stroke 480,0 kN (49,0 tonf)		17640 N (1800 kgf)
150	160	05	35,5			17640 N (1800 kgf)
150	160	10	35,9			18130 N (1850 kgf)
150	160	15	39,7			18130 N (1850 kgf)
150	160	20	43,6			18130 N (1850 kgf)
150	160	25	45,2			18522 N (1890 kgf)
150	160	30	50,0			18522 N (1890 kgf)
150	160	35	52,9			18816 N (1920 kgf)
150	160	40	59,2			18816 N (1920 kgf)
150	160	45	64,1			19012 N (1940 kgf)
150	160	50	73,1			19012 N (1940 kgf)
150	160	55	81,9			19698 N (2010 kgf)
150	160	60	96,6			19698 N (2010 kgf)
150	160	65	91,4			20188 N (2060 kgf)
150	160	70	84,7			20580 N (2100 kgf)
150	160	75	76,1			20384 N (2080 kgf)



Kam Kodu Cam Kode	Açı Angle (A)	Ölçüler / Dimensions (mm)						
		S	Ps	Ss	H1	B	B1	B2
AKHV-150	00	32,1	38,3	50	235,0	220	70	228,0
AKHV-150	05	35,5	38,4	50	230,6	210	70	237,2
AKHV-150	10	35,9	41,6	50	210,7	200	70	243,8
AKHV-150	15	39,7	42,4	50	205,0	195	70	251,7
AKHV-150	20	43,6	43,6	50	198,7	194	70	259,5
AKHV-150	25	45,2	47,8	50	182,6	202	60	282,9
AKHV-150	30	50,0	50,0	50	174,6	199	60	292,1
AKHV-150	35	52,9	55,3	50	169,7	201	60	304,7
AKHV-150	40	59,2	59,2	50	155,5	197	60	311,9
AKHV-150	45	64,1	66,4	50	147,7	182	20	305,8
AKHV-150	50	73,1	73,1	50	131,7	179	20	312,7
AKHV-150	55	81,9	84,2	50	120,8	186	20	327,3
AKHV-150	60	96,6	96,6	50	102,9	183	20	333,6
AKHV-150	65	91,4	93,2	40	94,5	183	20	339,2
AKHV-150	70	84,7	87,4	30	73,9	168	0	314,3
AKHV-150	75	76,1	77,0	20	65,1	167	0	318,2

Kam Kodu Cam Kode	Açı Angle (A)	Ölçüler / Dimensions (mm)						
		b1	b2	C	c1	c2	c3	c4
AKHV-150	00	85	150	310	25	270	54,0	117,0
AKHV-150	05	85	150	310	25	270	61,5	124,5
AKHV-150	10	85	150	310	25	270	69,0	132,0
AKHV-150	15	85	150	310	25	270	78,0	141,0
AKHV-150	20	85	150	310	25	270	85,5	148,5
AKHV-150	25	105	170	350	15	320	104,5	167,5
AKHV-150	30	105	170	350	15	320	112,0	175,0
AKHV-150	35	105	170	350	15	320	119,5	182,5
AKHV-150	40	105	170	350	15	320	127,0	190,0
AKHV-150	45	85	150	340	15	310	73,0	136,0
AKHV-150	50	85	150	340	15	310	79,0	142,0
AKHV-150	55	85	150	340	15	310	64,5	127,5
AKHV-150	60	85	150	340	15	310	71,5	134,5
AKHV-150	65	85	150	340	15	310	71,5	134,5
AKHV-150	70	70	135	340	15	310	71,5	134,5
AKHV-150	75	70	135	340	15	310	71,5	134,5

 Kod / Code	(G)	(A)
 ORDER AKHV	150	30