

AKBLN-68 Bilgilendirme / Information

- Çalışma Kuvveti / Working Force : (300.000 Baskı/Stroke) 29,4 kN (3,0tonf)
- Sürücü Geniřliđi / Slider Width : 68 mm
- Çalışma Açısı / Work Angle : 0° ~ 60°
- Pim Deliđi Ø12H7 (Opsiyon F13) / Dowel Pin Ø12H7 (Option F13)
- Sipariř Örneđi / Order Example : AKBLN-68-40

Kam Diyagram / Cam Diagram

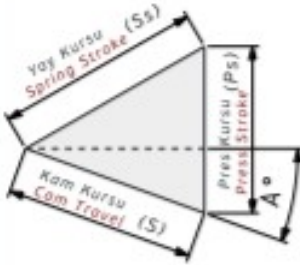

Sipariř Örneđi / Order Example

Kam Kodu Cam Code	Sürücü Geniřliđi Slider Width (mm)	Çalışma Açısı Work Angle (°)	Opsiyon Kodu / Option Code		
			Pim Deliđi Dowel Pin	---	---
AKBLN - 68 - 00					
AKBLN - 68 - 20 - F13					

AKBLN-68 Teknik Bilgiler / Technical Informations

Çalışma Yüzeyi/Mounting Surface		Çalışma Açısı Work Angle (°)	Kam Kuruřu/Cam Travel Stroke (mm)	Çalışma Kuvveti Working Force	Yay Kuvveti Spring Force	Gazlı Yay Kuvveti Gas Spring Force (Opsiyon/Option)
(G)	(Gh)					
68	84	00	33,9	300.000 Baskı/Stroke 29,4 kN (3,0 tonf)	1275 N (130 kgf)	
68	84	05	36,9		1275 N (130 kgf)	
68	84	10	39,9		1275 N (130 kgf)	
68	84	20	46,3		1275 N (130 kgf)	
68	84	30	53,5		1275 N (130 kgf)	
68	84	40	62,4		1275 N (130 kgf)	
68	84	50	74,4		1275 N (130 kgf)	
68	84	60	92,7		1275 N (130 kgf)	

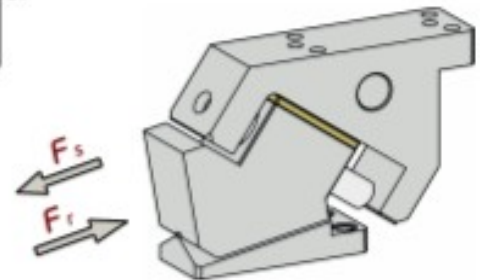
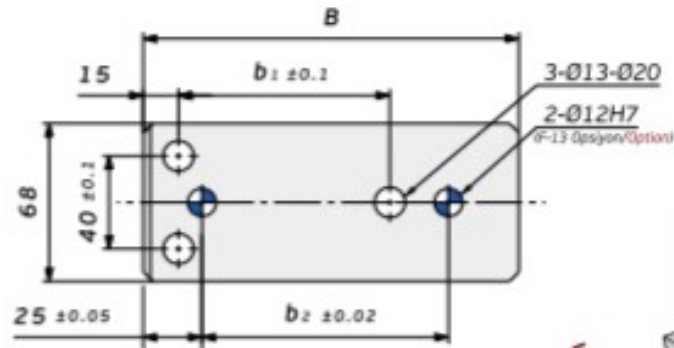
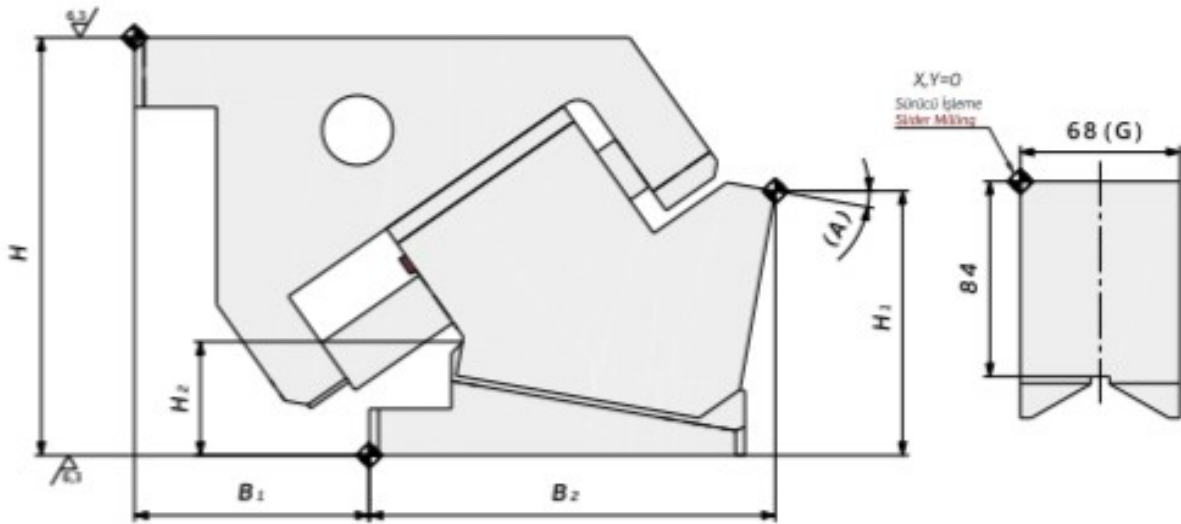
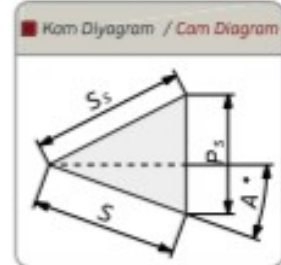
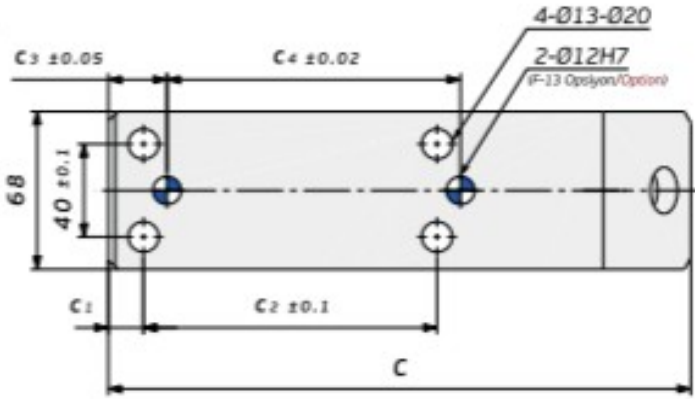

Kam Kodu Cam Kode	Açı Angle (A)	Ölçüler / Dimensions (mm)							
		S	P _s	S _s	H	H ₁	H ₂	B ₁	B ₂
AKBLN-68	00	33,9	33,9	48	180	130,00	43	135	125,00
AKBLN-68	05	36,9	34,1	48	180	122,22	46	130	141,95
AKBLN-68	10	39,9	34,4	48	180	113,87	49	100	172,59
AKBLN-68	20	46,3	36,1	48	180	98,83	57	75	201,84
AKBLN-68	30	53,5	39,2	48	180	86,61	70	50	191,42
AKBLN-68	40	62,4	44,3	48	180	72,98	82	60	206,56
AKBLN-68	50	74,4	52,8	48	190	62,71	100	50	207,25
AKBLN-68	60	92,7	67,9	48	200	48,58	110	35	208,61

Kam Kodu Cam Kode	Açı Angle (A)	Ölçüler / Dimensions (mm)							
		C	c ₁	c ₂	c ₃	c ₄	B	b ₁	b ₂
AKBLN-68	00	237	15	115	25	115	125	70	85
AKBLN-68	05	249	15	125	25	125	135	75	90
AKBLN-68	10	251	15	125	25	125	160	90	105
AKBLN-68	20	257	15	125	25	125	175	95	110
AKBLN-68	30	250	65	170	75	150	150	80	90
AKBLN-68	40	285	15	255	25	235	150	80	90
AKBLN-68	50	285	15	255	25	235	140	80	90
AKBLN-68	60	255	15	170	25	150	135	80	90

	Kod / Code	(G)	(A)
		AKBLN	68