

AKBK-65 Bilgilendirme / Information

- Çalışma Kuvveti / Working Force : (300.000 Baskı/Stroke) 39,2 kN (4,0 tonf)
- Sürücü Geniřlięi / Slider Width : 65 mm
- Çalışma Açısı / Work Angle : 0° ~ 70°
- Gazlı Yay Opsiyon / Gas Spring : GY
- Sipariř Örneęi / Order Example : AKBK-65-05-GY

Kam Diyagramı / Cam Diagram

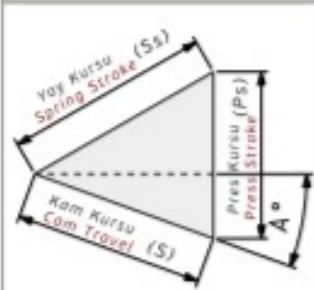

Sipariř Örneęi / Order Example

Kam Kodu Cam Code	Sürücü Geniřlięi Slider Width (mm)	Çalışma Açısı Work Angle (°)	Opsiyon Kodu / Option Code		
			Gazlı Yay Gas Spring	---	---
AKBK - 65 - 00	(G)	(A)	---	---	---
AKBK - 65 - 25 - GY					

AKBK-65 Teknik Bilgiler / Technical Informations

Çalışma Yüzeyi/Mounting Surface		Çalışma Açısı Work Angle (°)	Kam Kuruřu/Cam Travel Stroke (mm)	Çalışma Kuvveti Working Force	Yay Kuvveti Spring Force	Gazlı Yay Kuvveti Gas Spring Force (Opsiyon/Option)
(G)	(Gh)					
65	80	00	26,9	300.000 Baskı/Stroke 39,2 kN (4,0 tonf)	1067 N (109 kgf)	2520 N (260 kgf)
65	90	05	27,0		1138 N (116 kgf)	2520 N (260 kgf)
65	80	10	31,6		1138 N (116 kgf)	2520 N (260 kgf)
65	90	15	32,2		1138 N (116 kgf)	2520 N (260 kgf)
65	80	20	33,8		1138 N (116 kgf)	2520 N (260 kgf)
65	90	25	35,0		1138 N (116 kgf)	2520 N (260 kgf)
65	80	30	33,5		1138 N (116 kgf)	2520 N (260 kgf)
65	90	35	35,4	1.000.000 Baskı/Stroke 19,6 kN (2,0 tonf)	1138 N (116 kgf)	2520 N (260 kgf)
65	80	40	42,9		1138 N (116 kgf)	2520 N (260 kgf)
65	90	45	46,5		1138 N (116 kgf)	2520 N (260 kgf)
65	90	50	54,5		1138 N (116 kgf)	2520 N (260 kgf)
65	100	55	43,6		1040 N (106 kgf)	2520 N (260 kgf)
65	100	60	50,0		1040 N (106 kgf)	2520 N (260 kgf)
65	110	65	47,3		891 N (91 kgf)	2520 N (260 kgf)
65	80	70	58,5	891 N (91 kgf)	2520 N (260 kgf)	

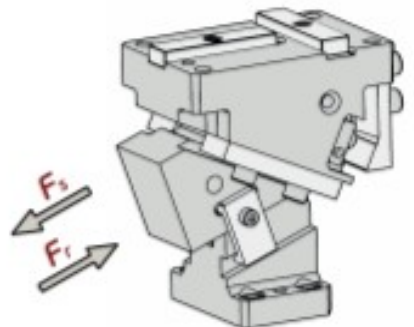
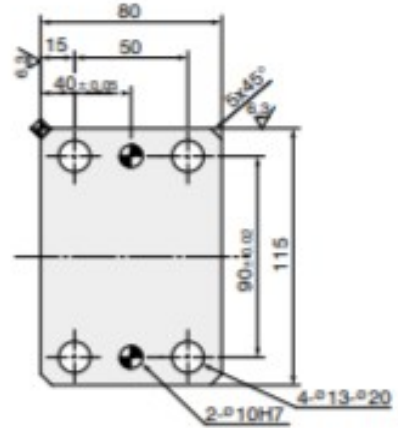
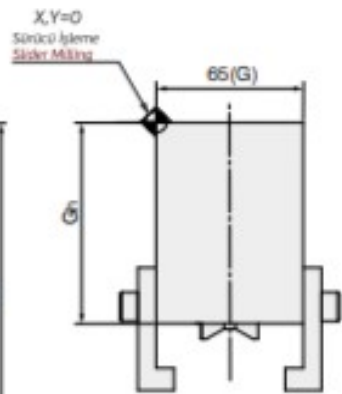
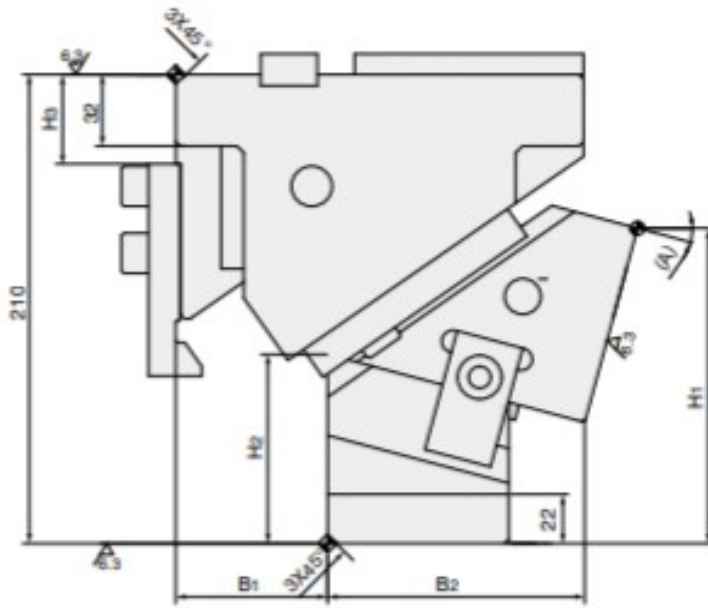
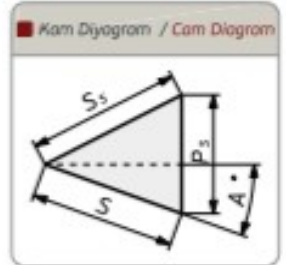
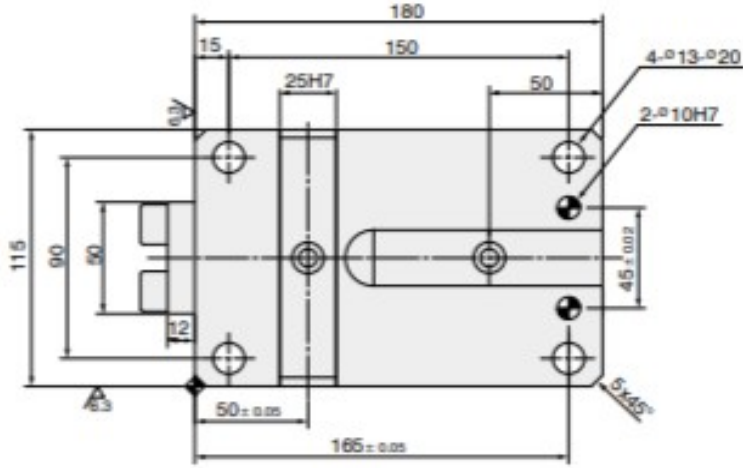

Kam Kodu Cam Kode	Açı Angle (A)	Ölçüler / Dimensions (mm)								
		S	P _s	S _s	H ₁	H ₂	H ₃	B ₁	B ₂	G _h
AKBK-65	00	26,9	26,9	38	153,4	73,4	55	75	110,9	80
AKBK-65	05	27,0	29,2	38	153,4	73,9	55	70	123,0	90
AKBK-65	10	31,6	27,3	38	142,4	83,5	40	70	126,8	80
AKBK-65	15	32,2	30,1	38	141,2	84,7	40	67	113,5	90
AKBK-65	20	33,8	26,3	35	135,7	100,8	10	60	138,1	80
AKBK-65	25	35,0	29,6	35	133,3	103,8	10	55	149,8	90
AKBK-65	30	33,5	24,5	30	120,5	111,0	10	50	143,6	80
AKBK-65	35	35,4	28,1	30	116,9	105,0	10	45	154,8	90
AKBK-65	40	42,9	30,5	33	110,4	120,0	15	40	148,7	80
AKBK-65	45	46,5	35,8	33	105,8	115,0	15	34	160,1	90
AKBK-65	50	54,5	41,7	35	100,0	130,0	10	30	160,0	90
AKBK-65	55	43,6	35,7	25	95,0	130,0	10	20	170,0	100
AKBK-65	60	50,0	43,3	25	95,0	130,0	10	20	170,0	100
AKBK-65	65	47,3	42,9	20	80,0	130,0	10	0	190,0	110
AKBK-65	70	58,5	54,9	20	80,0	130,0	10	0	190,0	80

 Kod / Code	(G)	(A)	Opsiyon / Option
AKBK	65	30	GY